



Performance You Can Trust

2025 PRODUCT
CATALOGUE
GLOBAL EDITION

Making better products in better ways.

- We select materials and processes that are more sustainable, and manufacturing that has less impact.
- Our products are designed to be more efficient, reducing energy use and carbon impact.
- We make products that are reliable, serviceable and built to last.

“We export our products to 86 countries across the world.”

● Numatic HQ - Somerset, UK ● Subsidiary Numatic Companies ● International Partners



“We continually review, refine and adapt our manufacturing processes to deliver even greater levels of sustainability throughout our product ranges.”

Chris Duncan
Chairman and Founder of Numatic International Ltd.

In 2025, our customers continue to face an array of complex and urgent challenges. Key priorities such as elevating cleaning and hygiene standards, optimising productivity and advancing sustainability remain at the forefront of our customers agendas. Addressing today’s demands while preparing for the challenges of tomorrow requires professional cleaning solutions that deliver **Performance You Can Trust.**

Delivering excellence in customer service and product performance across the globe.

Subsidiary Numatic companies are based in France, Germany, South Africa, The Netherlands, Switzerland, Portugal, Spain and Italy. Long-standing relations with trusted international partners across the globe position us to deliver quality service and product performance in all markets to all customers.



Head Office
Numatic International Limited
Chard, Somerset TA20 2GB
UNITED KINGDOM
Tel: +44 (0)1460 68600
numatic.com

Contents	Page
Sustainability	
Sustainability Formula	4
Net Zero by 2035	4-5
Sustainability in Action: ReFlo Technology, charity: water C Level Offsetting	6-7
Our Services	
ServiceCare	8
Digital Services: Nu-Assist, Nu-Design, Nu-Track	9
The Complete Cleaning Solution	10-11
HomeCare & Hi-Line	
The familiar faces of Henry and Friends bring reliability, quality and professional cleaning to every home.	12-21
HomeCare & Hi-Line Kits	22-23
CleanCare	
Bringing power, performance and reliability to our commercial cleaning product range.	24-49
CleanCare Kits	50-51
ProCare	
Advanced, professional cleaning for the collection and control of dust and hazardous substances.	52-59
ProCare Kits	60-61
FloorCare	
Providing innovative, reliable and effective floorcare solutions, even in the most demanding environments.	62-81
FloorCare Brushes/Pads & Accessories	82-85
VersaCare	
Raising cleaning standards and productivity with versatility, innovation and quality are at the core of our janitorial cleaning systems.	86-119

SUSTAINABILITY

Sustainability Formula

The Numatic Sustainability Formula is the foundation to all our product development and sustainable initiatives.

Our products are built to last with tried, tested and trusted designs, ongoing innovations and a commitment to developing sustainable cleaning solutions.

We ensure our products are the most efficient for every user; from water and detergent usage to electricity consumption.

Our products are designed to be easily and economically serviced throughout their lifecycle. We commit to support every product we have ever made, since day one.

We are committed to developing products using high-quality, recycled plastic. Right from their initial design, our products are manufactured to be easily recycled at the end of their life.

We work hard to ensure zero waste goes to landfill and have achieved this since 2017.

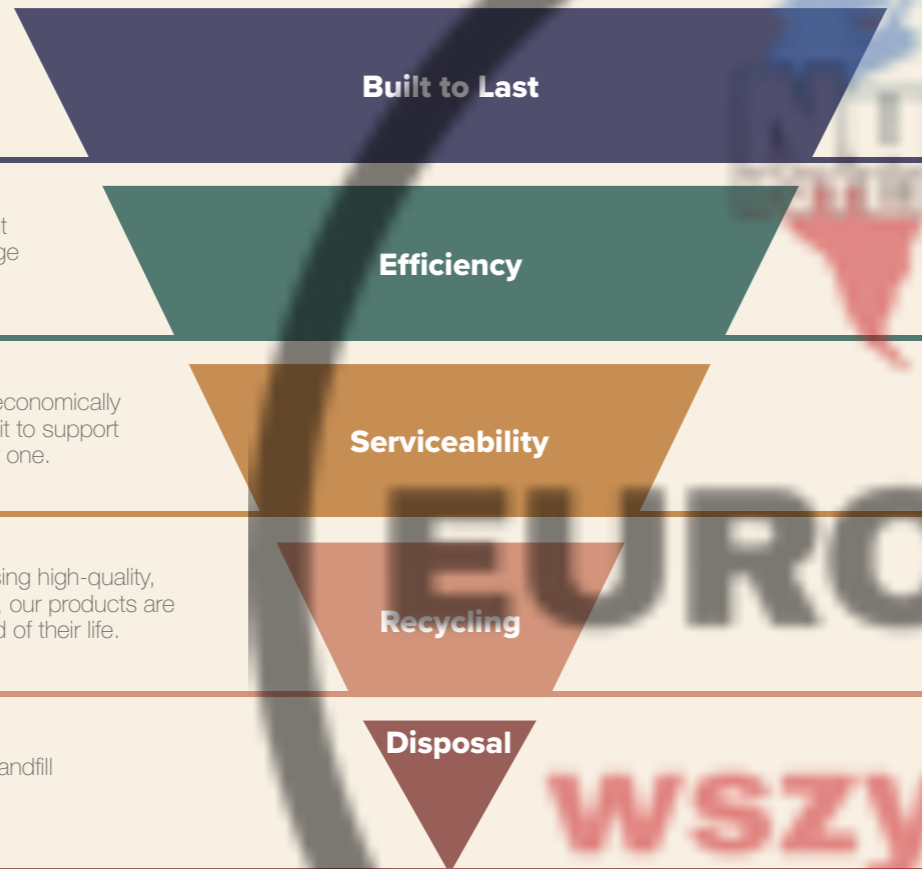

Integrated Sustainability

We recognise the need and demand for sustainable cleaning solutions and commit to initiatives across our business.

A sustainable approach is integrated throughout all of our operations, from design to manufacturing, to distribution and when in use. Our teams always strive to innovate and introduce even more sustainable manufacturing practices at our 42 acre site in Somerset, United Kingdom.

- Extensive Solar Investment
- Resource-Efficient Technologies
- Zero Waste to Landfill
- Sustainable Product Lifecycle
- LED Lighting

Carbon Neutral

From 2024 Numatic has reached carbon neutrality for Scope 1 and 2 emissions, marking a significant milestone in our commitment to sustainability.

We support the following Sustainable Development Goals (SDGs) of the United Nations:



Sustainability Roadmap

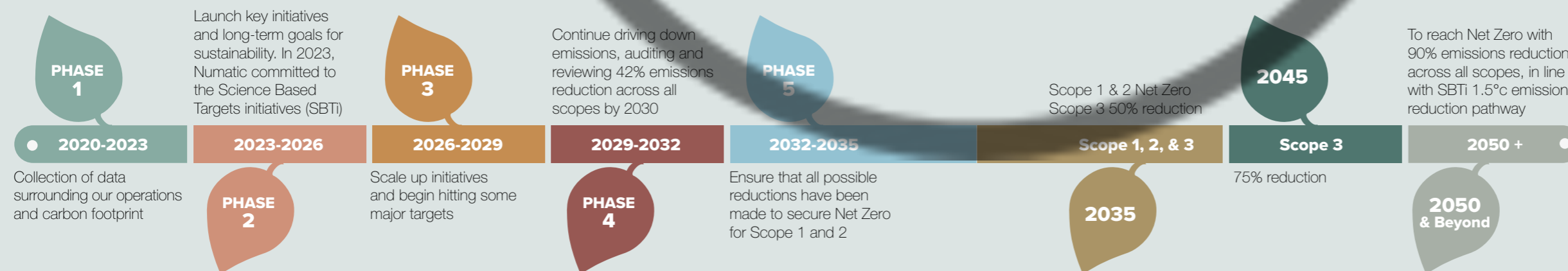

- Scope 1**
Direct emissions produced by our company facilities and our company vehicles.
- Scope 2**
Indirect emissions from purchased electricity, steam, heating and cooling used for our own use.
- Scope 3**
Emissions covered by Scope 3 include our upstream and downstream operations.

Sustainability in Action

Achieving ambitious sustainability targets requires innovation, action and transparency. These initiatives move us forward in reaching our goals and leading the way in providing sustainable cleaning solutions for our customers.

Sustainability is broader than just reducing our carbon footprint. True sustainability is helping others to be sustainable in their everyday practices, ensuring the earth and its communities are cared for.

Our ReFlo produced Janitorial Range of products carry the globally recognised SCS Recycled Content Certification. Working with an independent auditing body provides complete transparency and assurance to our customers. All our products certified by SCS Global Services guarantee a minimum amount of recycled material is used.



charity: water



numatic.com/sustainability



ReFlo Technology

Many of our products are made using ReFlo recycling plastic reducing the use of virgin plastic wherever possible, whilst maintaining the same quality and durability in our products. ReFlo Technology uses high-quality, post-industrial and post-consumer plastics across the Numatic range.

Following extensive research and testing, we have introduced ReFlo Technology to our FloorCare range, joining our VersaCare Janitorial and CleanCare Vacuum ranges.

Made from the highest quality, recycled plastic.



The Bigger Picture

We've partnered with charity: water to provide water to communities and projects that need it the most. Through every purchase of a NuClean Compact Scrubber Dryer, we donate the equivalent of 5000L of water. Nepal, Piped system tap stand.

Working in partnership with:

charity: water

Our most recent completed project took place in Nepal, positively impacting a total of 596 people.

Over 145 MILLION Litres of water funded since launch in 2021.

Every NuClean Compact Scrubber Dryer provides 5000L of water to communities that need it.



Not Just Any Offsetting

We've been reducing our carbon footprint and offsetting global bag sales since 2020. We've partnered with a leading company in carbon offsetting innovation, C Level.

TARGETS AND INITIATIVES

We recognise the need and demand for sustainable cleaning solutions and commit to initiatives across our business.

This includes becoming Net Zero by 2035 (for Scope 1 and 2), setting incremental targets to keep us on track. Numatic has joined the Science Based Targets Initiative (SBTi), setting ambitious emissions reduction targets in line with the latest climate science.

While we work on reducing our emissions, we have taken additional measures to reduce our impact on the planet by carbon balancing our Scope 1 and 2 emissions through our trusted offsetting partner, C Level.

Net Zero by 2035



DRIVING AMBITIOUS CORPORATE CLIMATE ACTION



SERVICECARE

We believe cleaning floors should be simple. It's about having the right equipment and right support; it really doesn't have to be more complicated than that. Simple cleaning, complete support.

Numatic ServiceCare

Cleaning Productivity Made Simple

We work with you at every turn, equipping you with all you need to maintain the highest cleaning standards.

For extra peace of mind, our full-service contracts cover you for any accidental damage or breakdowns, including two visits every year to service your machine.

Available in the UK. Local market availability may vary, contact your Numatic representative for more information.

- Installation & Set-up
- Cleaning Maintenance
- Operator Training
- Top-up Training

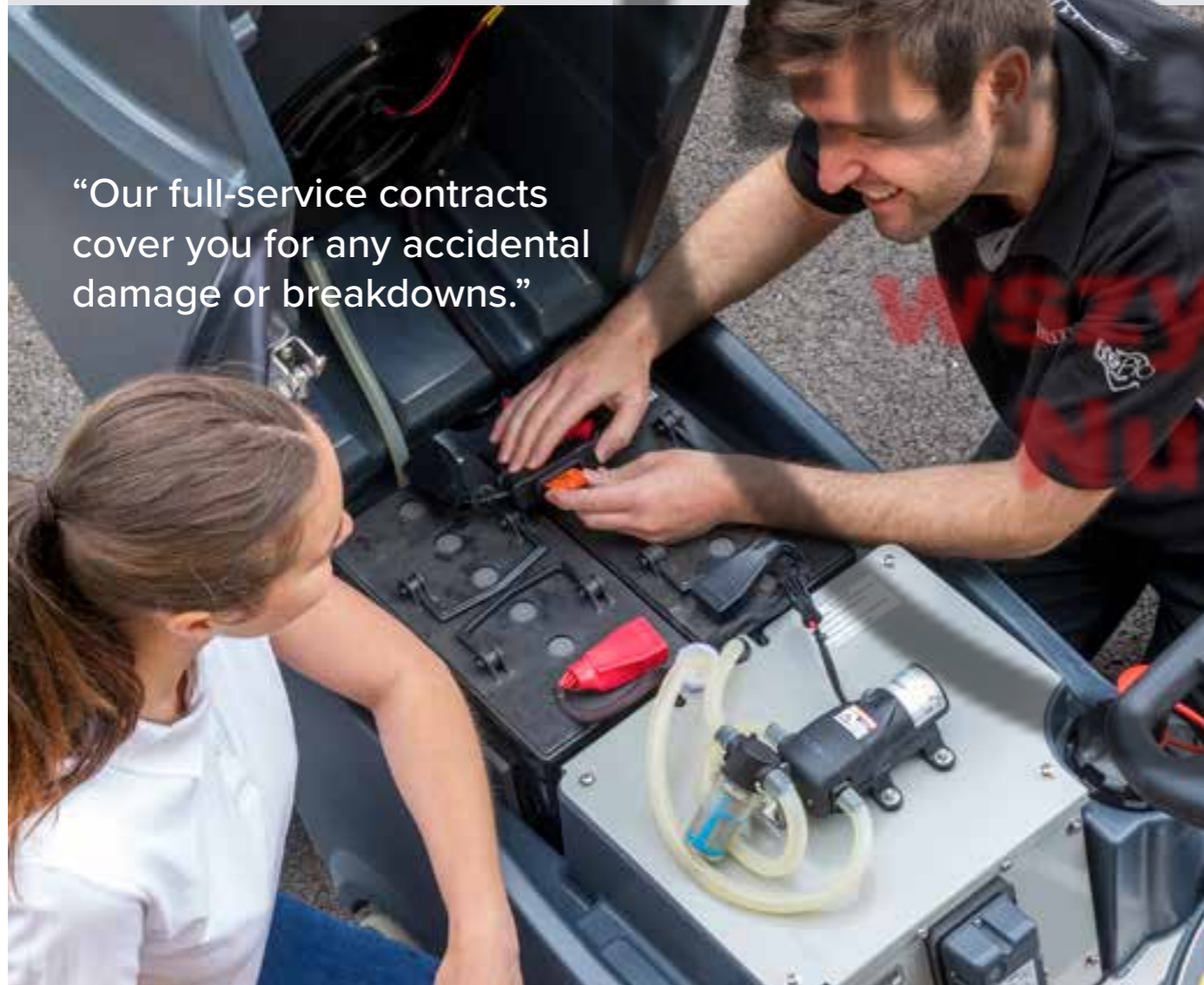

“Our full-service contracts cover you for any accidental damage or breakdowns.”

DIGITAL SERVICES

“Increase cleaning productivity with training and support at your fingertips.”

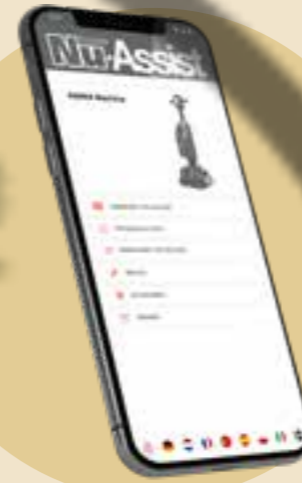

Nu-Assist

Increase Cleaning Productivity

The Nu-Assist App offers the benefit of online training through a simple, versatile and user-friendly solution, resulting in increased cleaning performance and productivity.



Nu-Design

Bespoke Trolley Configurator

Nu-Design guides you through the product to configuration process, providing a visual output and configuration breakdown at each selection. The result; a reliable, functional and innovative cleaning system that meets your needs precisely.



Nu-Track

Intelligent Fleet Management

Understand how, when and where your cleaning fleet is operating. Each asset automatically uploads status, location and usage reports to portal.



THE COMPLETE CLEANING SOLUTION

The UK's most comprehensive range of cleaning solutions, serving customers in all industries.



Healthcare

Working closely with the Healthcare industry, raising cleaning standards and productivity.

Maintaining the highest standard of cleanliness and hygiene can be challenging, when working against the demands and pressures of a busy and diverse hospital, clinic or care home. You need cleaning equipment that meets your needs completely.



Hospitality

You don't get a second chance at a first impression.

In a demanding hospitality setting, where cleaning tasks are frequent and often intensive, durability is crucial. Numatic equipment is built to withstand continuous use and is designed to handle the challenges of commercial cleaning.



Education

Creating clean environments to work, learn and play.

Clean environments don't only deliver increased hygiene and safety, but also more positive, creative and comfortable environments for their users.



Construction

Robust and reliable equipment that has the power and performance to tackle whatever you throw at it.

Offering industrial-grade construction, advanced filtration to H-Class and equipment for every eventuality, ready to withstand the drops, bangs and scrapes that can happen frequently in the professional trade environment.



Logistics & Handling

Increasing cleaning performance and productivity for the Logistics & Handling industry around the clock.

When business is operating around the clock, it becomes even more important to have access to the right equipment for the right job. That equipment also needs to yield maximum productivity, delivering the results you need, when you need them, without fail.



Facilities Management

Collaborating with the Facilities Management industry delivering on high-quality, bespoke cleaning equipment for every sector.

Customers are seeking to overcome new challenges and solve problems; we have the solution. Whether you need to clean large shopping centres, busy supermarkets, compact store floors or open office spaces, our cleaning solutions deliver advanced cleaning results with maximum cleaning productivity.



HomeCare & Hi-Line

Powerful cleaning from the UK's best-selling vacuum.

Contents

Henry / Hetty Quick	14-15
Henry / Hetty 160	16
Henry Xtra 160	16
Henry Petcare 160	16
Henry Allergy 160	16
Henry / Hetty Eco 160	17
George	18
Henry Wash	19
Charles	19
Henry / Hetty SprayMop	19
Henry / Hetty 200	20
Henry 170 / 170 HEPA	20
James	21
Henry Xtra 200	21
Henry 240	21
Henry Petcare 200	21
HomeCare & Hi-Line Accessories & Kits	22-23



Page 16 Henry



Page 19 Henry Wash



Page 14 Henry Quick

“Lightweight & so easy to use. Love it. Good suction & ideal on wooden floors & on carpets.”

Claire
6 April 2024

★ **Trustpilot**

★ ★ ★ ★ ★



Page 21 Henry HVR240

HENRY QUICK

Cordless Vacuum Cleaner



What's in the box?

Extended-Use Handle	✓	✓	✓	✓
Wall Dock	✓	✓	✓	✓
Charger & Battery	✓	✓	✓	✓
2-in-1 Combi & Crevice Tool	✓	✓	✓	✓
Henry Quick Pods	x6	x6	x6	x6
Scent Pods	x1	x1	x1	x10
Mini Motorised Tool	✗	✗	✗	✓



1L Pod Capacity	300W Motor	70mins Runtime	3.2KG Weight
Power 25.2V		Recharge Time 2.5hrs - 100%	
240x270x1220mm (WxLxH)		Accessories (see page 23)	

Available in Henry Quick Red, Grey, Hetty Quick Pink and Henry Quick Pet Blue

Figures displayed are with Brush Head off. Run and recharge times may vary dependent on ambient temperature and expected battery ageing.

“Love love love! **Best vacuum cleaner I've ever had.** So easy to use. **Robust. No mess.** Brilliant design. **Great value.**”



- 1 One-click Dust-free Emptying
- 2 Handy Tools
- 3 Compacts dust inside the pod for more capacity than most leading vacuums. With 5 layers of filtration and 99% efficiency at 0.3-0.5 microns.

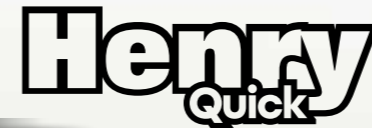

Upgrade your Henry Quick with a Pro Accessory Kit.

Includes: Flexi Hose, Flexi Crevice Tool, Soft Dusting Brush, Mini Motorised Tool and 10 x Scent Pods.



4 x PRO Accessories Included

“Ready to go wherever you are for quick, easy and lightweight cleaning.”



1 Soft Dusting Brush 2 Flexi Crevice Tool 3 Flexi Hose 4 Mini Motorised Tool 5 Scent Pods

“Henry is the UK’s **best-selling** vacuum.”

HENRY

Henry Eco

30% Energy Savings



HENRY HVR160 / HETTY HET160



- Carpets, hard-floors, cars, stairs, DIY
- Handy on-board tool storage
- A tool for every job
- Emptying with no dust and no mess

6L Capacity	620W Motor	7.5KG Weight
Power 230V / AC 50/60Hz	Cleaning Range 25.7m	
Power Cord 10m	Suction H ₂ O 2300mm	
320x340x345mm (WxLxH)	Kit AS0 (see page 22)	

HENRY XTRA HVX160



- Powerful AiroBrush270 for carpets
- Specialist Hard Floor Tool
- A tool for every job
- Handy on-board tool storage
- Emptying with no dust and no mess

6L Capacity	620W Motor	7.5KG Weight
Power 230V / AC 50/60Hz	Cleaning Range 25.7m	
Power Cord 10m	Suction H ₂ O 2300mm	
320x340x345mm (WxLxH)	Kit XS0 (see page 22)	

HENRY PETCARE HPC160



- Powerful AiroBrush270 for stubborn pet hair on carpets
- Compact AiroBrush140 tackles pet hair on the stairs, sofa and in the car
- Odour-reducing MicroFresh Filter
- Emptying with no dust and no mess

6L Capacity	620W Motor	7.7KG Weight
Power 230V / AC 50/60Hz	Cleaning Range 25.7m	
Power Cord 10m	Suction H ₂ O 2300mm	
320x340x345mm (WxLxH)	Kit HS0 (see page 22)	



HENRY ALLERGY HVA160



- High-performance Combi Floor Tool
- Specialist FreeFlo Hard Floor Tool
- Advanced, 3-stage Hepa13 filtration
- Handy on-board tool storage
- Emptying with no dust, no mess, no allergens

6L Capacity	620W Motor	7.7KG Weight
Power 230V / AC 50/60Hz	Cleaning Range 25.7m	
Power Cord 10m	Suction H ₂ O 2300mm	
320x340x345mm (WxLxH)	Kit AS9 (see page 22)	

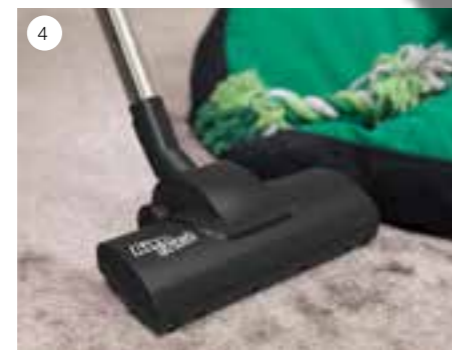

HENRY HVR160 ECO / HETTY HET160 ECO



- Our highest efficiency motor yet
- 30% reduction in energy consumption
- Powerful EcoBrush for stubborn dust, dirt and pet hair

6L Capacity	420W Motor	7.7KG Weight
Power 230V / AC 50/60Hz	Cleaning Range 25.7m	
Power Cord 10m	Suction H ₂ O 1750mm	
320x340x345mm (WxLxH)	Kit HS1 (see page 22)	

Using our 420W high-efficiency motor, the Eco Range delivers powerful cleaning while reducing energy usage and cost.*

Annual Energy Usage



- 1 Henry Xtra 160
- 2 Specialist Hard Floor Tool
- 3 AiroBrush140
- 4 AiroBrush270
- 5 Combi Floor Tool
- 6 EcoBrush190

WET Vacuum Range

George

Whether you want to deep-clean the carpet, suck up spills, unblock the sink, freshen-up furniture, valet the car or vacuum the floor, George is ready to save the day.



George
1 Dual Scrub Wet Pick-Up Tool
2 Fishtail Extraction Tool

GEORGE GVE370



- 4-in-1 wet, dry, extraction and upholstery
- Revive carpets, clean hard-floors, refresh the sofa, valet the car, suck-up spills and even unblock the sink

15L / 9L Capacity Dry / Wet	6L Extraction Capacity	1000W Motor	11.2KG Weight
Power 230V / AC 50/60Hz		Cleaning Range 26.8m	
Power Cord 10m		Suction H ₂ O 2400mm	
360x370x510mm (WxLxH)		Kit A26A (see page 22)	



HENRY WASH HVW370



- Shampoo carpets, clean hard-floors
- Valet the car, refresh the sofa
- Emergency clean-ups and DIY

9L / 6L Capacity / Extraction	1000W Motor	10.6KG Weight
Power 230V / AC 50/60Hz		Cleaning Range 26.9m
Power Cord 10m		Suction H ₂ O 2400mm
360x370x510mm (WxLxH)		Kit AH6 (see page 22)



CHARLES CVC370



- Versatile wet and dry toolkit
- Blocked sinks, showers, household leaks, spills, DIY, car, home

15L / 9L Capacity Dry / Wet	1000W Motor	9KG Weight
Power 230V / AC 50/60Hz		Cleaning Range 26.4m
Power Cord 10m		Suction H ₂ O 2400mm
360x370x510mm (WxLxH)		Kit A21A (see page 22)

HENRY & HETTY SPRAYMOP

- Perfect all-rounder
- Swivel design
- Easy-fit mop pads
- On-board liquid dispenser
- Use again and again



Henry & Hetty SprayMop
6 Easy-fill Liquid Dispenser
7 Foot & Hand Pump to Release Liquid

“The cleaning power is astonishing - stains we thought were permanent have faded or disappeared completely! Very pleased.”

Susan
4 October 2024

★ Trustpilot

★★★★★



Henry Wash
3 Fishtail Extraction Tool

Charles
4 Convenient Carry Handle
5 MultiFlo Wet Pick-Up Tool

HENRY

Hi-Line Range

“With over **16 million** made, and most still in use... **Henry truly is the vacuum you can trust.**”

Henry

HENRY HVR200 / HETTY HET200



- Versatile toolkit
- Carpets, hard-floors, cars, stairs, DIY
- Handy on-board tool storage
- Emptying with no dust and no mess

9L Capacity	620W Motor	8KG Weight
Power 230V / AC 50/60Hz	Cleaning Range 26.4m	
Power Cord 10m	Suction H ₂ O 2300mm	
340x360x370mm (WxLxH)	Kit AS0 (see page 22)	

Henry Original
The original 200 series, a trusted and familiar face on the outside with the latest innovation inside.



Henry200

JAMES JVP180



- Versatile toolkit
- Carpets, hard-floors, cars, stairs, DIY
- Convenient cable replacement system
- Handy on-board tool storage
- Emptying with no dust and no mess

8L Capacity	620W Motor	6KG Weight
Power 230V / AC 50/60Hz	Cleaning Range 26.4m	
Power Cord 10m	Suction H ₂ O 2300mm	
340x365x360mm (WxLxH)	Kit AS0 (see page 22)	

HENRY XTRA HVX200



- Powerful AiroBrush270 for carpets
- Specialist Hard Floor Tool
- Carpets, hard-floors, cars, stairs, DIY
- Handy on-board tool storage
- Emptying with no dust and no mess

9L Capacity	620W Motor	8KG Weight
Power 230V / AC 50/60Hz	Cleaning Range 26.4m	
Power Cord 10m	Suction H ₂ O 2300mm	
340x360x370mm (WxLxH)	Kit XS0 (see page 22)	

HENRY HVR240



- Carpets, hard-floors, cars, stairs, DIY
- Bumper for wall and door protection
- Handy on-board tool storage
- Emptying with no dust and no mess

9L Capacity	620W Motor	9KG Weight
Power 230V / AC 50/60Hz	Cleaning Range 26.4m	
Power Cord 10m	Suction H ₂ O 2300mm	
360x370x415mm (WxLxH)	Kit AS0 (see page 22)	

HENRY HVR170



- Versatile toolkit
- Carpets, hard-floors, cars, stairs, DIY
- Handy on-board tool storage
- Emptying with no dust and no mess

7.2L Capacity	620W Motor	8KG Weight
Power 230V / AC 50/60Hz	Cleaning Range 26.4m	
Power Cord 10m	Suction H ₂ O 2300mm	
360x370x390mm (WxLxH)	Kit AS0 (see page 22)	

Advanced HEPA13 Filtration

HENRY HVR170 HEPA



- Versatile toolkit
- Carpets, hard-floors, cars, stairs, DIY
- Certified HEPA13 filtration down to 0.3 microns at 99.95% efficiency
- Handy on-board tool storage
- Emptying with no dust and no mess

7.2L Capacity	620W Motor	8.2KG Weight
Power 230V / AC 50/60Hz	Cleaning Range 26.4m	
Power Cord 10m	Suction H ₂ O 2300mm	
360x370x390mm (WxLxH)	Kit AS0 (see page 22)	

HEPA13 Filter Cartridge

High-efficiency TriTex Filter

Triple-layer HepaFlo Filter Bag



Henry Petcare

Driven by Henry's powerful airflow, the AiroBrush270 easily picks-up stubborn pet hair from carpets.

HENRY PETCARE HPC200



- Powerful AiroBrush270 for stubborn pet hair on carpets
- Compact AiroBrush140 tackles pet hair on the stairs, sofa and in the car
- Odour-reducing MicroFresh Filter
- Carpets, hard-floors, cars, stairs, DIY
- Emptying with no dust and no mess

9L Capacity	620W Motor	8KG Weight
Power 230V / AC 50/60Hz	Cleaning Range 26.4m	
Power Cord 10m	Suction H ₂ O 2300mm	
340x360x370mm (WxLxH)	Kit HS0 (see page 22)	



Henry Petcare 200

HOMECARE & HI-LINE

KITS

KIT AS0 - 903146



601008	Stainless Steel Extension Tube (x2)
601052	Stainless Steel Tube Bend with NPC Volume Control
915909	2m FloMax Conical Hose
912358	280mm ProFlo Combination Floor Tool
601141	Double Taper Hose / Tool Adaptor
601142	240mm Crevice Tool
601144	65mm Soft Dusting Tool
601145	150mm Upholstery Tool
601146	150mm Slide-on Brush Tool

KIT AS9 - 909193



601008	Stainless Steel Extension Tube (x2)
601052	Stainless Steel Tube Bend with NPC Volume Control
914411	2m FloMax Conical Hose
912358	280mm ProFlo Combination Floor Tool
601430	290mm FreeFlo Floor Tool
601141	Double Taper Hose / Tool Adaptor
601142	240mm Crevice Tool
601144	65mm Soft Dusting Tool
601145	150mm Upholstery Tool
601146	150mm Slide-on Brush Tool

KIT XS0 - 909146

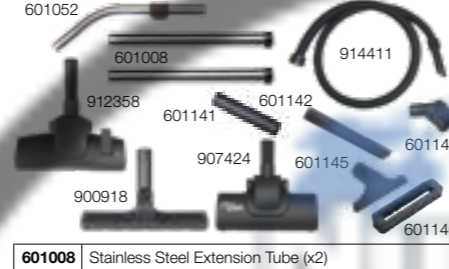

601008	Stainless Steel Extension Tube (x2)
601052	Stainless Steel Tube Bend with NPC Volume Control
914411	2m FloMax Conical Hose
912358	280mm ProFlo Combination Floor Tool
907424	AiroBrush270 Turbo Brush
900918	300mm MultiFlo Dry Brush Tool
601141	Double Taper Hose / Tool Adaptor
601142	240mm Crevice Tool
601144	65mm Soft Dusting Tool
601145	150mm Upholstery Tool
601146	150mm Slide-on Brush Tool

KIT HS0 - 909184



601008	Stainless Steel Extension Tube (x2)
601052	Stainless Steel Tube Bend with NPC Volume Control
914411	2m FloMax Conical Hose
912358	280mm ProFlo Combination Floor Tool
907424	AiroBrush270 Turbo Brush
907475	AiroBrush140 Hand Turbo Brush
601141	Double Taper Hose / Tool Adaptor
601142	240mm Crevice Tool
601144	65mm Soft Dusting Tool
601145	150mm Upholstery Tool
601146	150mm Slide-on Brush Tool

KIT HS1 - 607361



601008	Stainless Steel Extension Tube (x2)
601052	Stainless Steel Tube Bend with NPC Volume Control
914411	2m FloMax Conical Hose
912358	280mm ProFlo Combination Floor Tool
601228	EcoBrush190 Turbo Brush
601141	Double Taper Hose / Tool Adaptor
601142	240mm Crevice Tool
601144	65mm Soft Dusting Tool
601145	150mm Upholstery Tool
601146	150mm Slide-on Brush Tool

KIT A21A - 607221



601008	Stainless Steel Extension Tube (x2)
601052	Stainless Steel Tube Bend with NPC Volume Control
914413	2m Parallel Hose
902071	300mm Combination Floor Tool
900954	300mm MultiFlo Wet Pick-up Tool
601141	Double Taper Hose / Tool Adaptor
601142	240mm Crevice Tool
601144	65mm Soft Dusting Tool
601145	150mm Upholstery Tool
601146	150mm Slide-on Brush Tool

KIT AH6 - 911124



908584	Stainless Steel Trigger Valve Wand
601008	Stainless Steel Extension Tube (x2)
907235	100mm Upholstery Extraction Tool
914766	2.5m Bayonet Hose
578002	275mm Fishtail Extraction Tool
907474	300mm Dual Scrub / Wet Pick-up Tool
907233	Spray Tube C/W x2 clips
907234	2.9m Solution Tube C/W x6 clips

KIT A26A - 607326

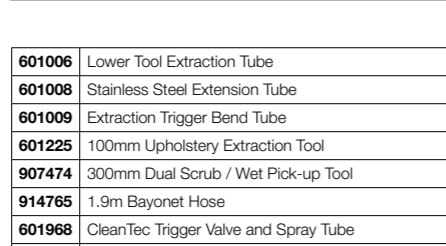

601006	Lower Tool Extraction Tube
601008	Stainless Steel Extension Tube
601009	Extraction Trigger Bend Tube
601225	100mm Upholstery Extraction Tool
907474	300mm Dual Scrub / Wet Pick-up Tool
914765	1.9m Bayonet Hose
601968	CleanTec Trigger Valve and Spray Tube
601299	3m CleanTec Extraction Hose
601126	275mm Fishtail Extraction Tool
902071	300mm Combination Floor Tool
601141	Double Taper Hose / Tool Adaptor
601142	240mm Crevice Tool
601144	65mm Soft Dusting Tool
601145	150mm Upholstery Tool
601146	150mm Slide-on Brush Tool



601009	Lower Tool Extraction Tube
601008	Stainless Steel Extension Tube
601968	CleanTec Trigger Valve and Spray Tube
601126	275mm Fishtail Extraction Tool
601141	Double Taper Hose / Tool Adaptor
601142	240mm Crevice Tool
601144	65mm Soft Dusting Tool
601145	150mm Upholstery Tool
601146	150mm Slide-on Brush Tool

ACCESSORIES

HENRY HEPAFLO BAGS

5 Bag Pack (NVM-1CH) 907076
10 Bag Pack (NVM-1CH) 907075

Designed for Henry, by Henry
Henry Bags are the perfect fit, maximising capacity and airflow, delivering peak suction.
All Numatic vacuum bags are 100% carbon balanced.

Genuine Henry HepaFlo Bags are suitable for use with Henry, Hetty, Harry and James.



HENRY QUICK PODS

Dust-Free Emptying
Advanced, multi-layer filtration with Dust Lock Seal for one-click, dust-free emptying.
10 x Pods 915744



HENRY / HETTY QUICK BOXED ACCESSORIES

915242	UK Plug and Cable
915243	EURO Plug and Cable
915170	Quick Battery
915351	Wall Dock
915353	Extended-Use Handle
914303	Motorised Floor Tool (Red)
914305	Motorised Floor Tool (Pink)
914746	Motorised Floor Tool (Grey)
915352	Quick Handy Kit
915358	Brush Bar
915527	Mini Motorised Tool
915354	Wand (Red)
915355	Wand (Pink)
915356	Wand (Grey)
915629	Handheld Unit (Red)
915630	Handheld Unit (Pink)
915631	Handheld Unit (Grey)
914593	Vanilla Scent Pods (Pack of 10)
915350	Passionfruit Scent Pods (Pack of 10)
915674	Rose Scent Pods (Pack of 10)
915357	Scent Pod Cap



PRO ACCESSORY KITS

Henry ProKit 909257

- Includes:
□ AiroBrush270
□ AiroBrush140
□ Hard Floor Tool

Intended for dry use only.



Henry Quick Pro Kit 919221

The **Henry Quick ProKit** has been designed to provide the best possible and most convenient cleaning results from your Henry Quick Pro.

Henry Quick Pro Tools include:

- Flexi Hose
□ Flexi Crevice Tool
□ Soft Dusting Brush



BOXED ACCESSORIES

909585	280mm ProFlo Combination Floor Tool
909553	AiroBrush270 Turbo Brush
909554	AiroBrush140 Hand Turbo Brush
909555	300mm MultiFlo Dry Brush Tool
909556	Multi Angle Tool
909557	2m FloMax Conical Hose
909558	Flexi Crevice Tool
909560	TriTex Filter 11" / 280mm
909559	TriTex Filter 12" / 305mm
909562	MicroFresh Filter 11" / 280mm
909561	MicroFresh Filter 12" / 305mm
909563	32mm Stainless Steel Tube Set
909564	Handy Kit (A4)
909587	Mattress Tool + Slide-on Brush
909565	Crevice Tool
909566	Soft Dusting Tool
909567	Henry Kit (AS0)
909257	Henry ProKit
919221	Henry Quick ProKit
912405	PetKit 11"
910295	PetKit 12"
911812	Car and Stair Kit
912180	Reach Kit



CleanCare

CleanCare brings power, performance and reliability to our commercial cleaning product range.

Contents

Eco ReFlo Range	26-27
ProLine Range	28-29
Numatic Quick	30-31
NX300 Pro Cordless Network	32-39
Mains Cable Backpacks	40
Steel Tops	41
MicroLine	41
Aircraft Line	42
Dry Big Capacity Vacuums	43
Wet Vacuums	44-45
Wet & Dry Vacuums	46
Carpet Extraction Vacuums	47-49
CleanCare Kits & Accessories	50-51



NEW PRODUCT

Page 34 CTB370NX & X-tract



NEW PRODUCT

Page 37 NBV240NX HEPA

“Quality and cleaning innovation from the global leading professional vacuum brand.”



Page 26 ERP180

ECO REFLO

30% Energy Saving Vacuums

Works Harder, Lasts Longer, Built Smarter

Made using ReFlo recycled plastic, reducing the use of virgin plastic wherever possible, whilst maintaining quality and durability in our products.

ERP180

Made using 45% Recycled Plastic



- High-efficiency, economical cleaning
- Made using a minimum 45% recycled plastic, including accessories
- Carpets, hard-floors, cars, stairs, DIY
- Handy on-board tool storage
- Plugged cable

8L Capacity	420W Motor	6KG Weight
Power 230V / AC 50/60Hz		Cleaning Range 26.4m
Power Cord 10m		Suction H ₂ O 1750mm
340x360x360mm (WxLxH)		Kit AS0 (see page 50)

EPR170

Made using 25% Recycled Plastic



- Equipped with our highest efficiency motor yet
- Carpets, hard-floors, cars, stairs, DIY
- Extra reach 12.5m cable with trouble-free rewind and additional on-board tool storage
- Made using a minimum 25% recycled plastic, including accessories
- Plugged cable
- Emptying with no dust and no mess

7.2L Capacity	420W Motor	8.1KG Weight
Power 230V / AC 50/60Hz		Cleaning Range 31.4m
Power Cord 12.5m		Suction H ₂ O 1750mm
360x370x390mm (WxLxH)		Kit AS0 (see page 50)

EPR170 HEPA

Made using 25% Recycled Plastic



- Equipped with our highest efficiency motor yet
- Carpets, hard-floors, cars, stairs, DIY
- Certified HEPA13 filtration down to 0.3 microns at 99.95% efficiency
- Made using a minimum 25% recycled plastic, including accessories
- Plugged cable
- Emptying with no dust and no mess

7.2L Capacity	420W Motor	8.3KG Weight
Power 230V / AC 50/60Hz		Cleaning Range 31.4m
Power Cord 12.5m		Suction H ₂ O 1750mm
360x370x390mm (WxLxH)		Kit AS0 (see page 50)

ERP180
45%
Minimum Recycled Plastic Content
Including All Accessories



NUMATIC
Eco-ReFlo
ERGO-MATIC
Przystko do
Numatic



1 Long-Reach Hi-Vis 10m Cable
2 Powerful Cleaning on Carpets & Hard Floors
3 Cable Tidy & Carry Handle (ERP180)

Calculate Your Savings

Find out how much money you could save every year by switching to an Eco ReFlo Vacuum by visiting numatic.com/ERP180 or scanning the QR Code



Annual Energy Usage

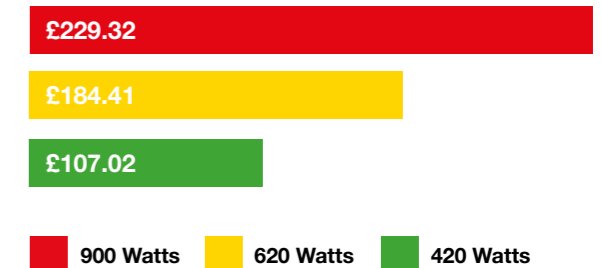

Potential savings provided for guidance only, actual savings may differ dependent on usage and energy cost. Based on using 4 hours per day, over 260 days and £0.245 kWh (as of 10/24 UK).



“Made using the highest quality recycled plastic.”

PROLINE

Powerful Professional Cleaning

PRP180 / PRP240 / PRP370

ReFlo Technology uses high-quality recycled, post-industrial and post-consumer plastics across the Numatic range.



- PRP180 - Made using a minimum 45% recycled plastic, including accessories
- PRP240/PRP370 - Made using a minimum 20% recycled plastic, including accessories
- Carpets, hard-floors, cars, stairs, DIY
- Handy on-board tool storage
- Professional accessory kit
- Plugged cable

8L / 9L / 15L Capacity		620W Motor	6KG / 8KG / 9KG Weight	
Power 230V / AC 50/60Hz	Power Cord 10m	Cleaning Range 26.4m	Suction H ₂ O 2300mm	
340x360x360mm (180), 360x370x415mm (240), 360x370x510mm (370) (WxLxH)			Kit AS0 (see page 50)	

PPR170 PPR170 HEPA



- Easy replacement plugged cable system
- Bumper for wall and door protection
- Compact and convenient
- Made using a minimum 25% recycled plastic, including accessories
- Emptying with no dust and no mess
- Certified HEPA13 filtration down to 0.3 microns at 99.95% efficiency (PPR170H Only)

7.2L Capacity	620W Motor	8.1KG / 8.3KG Weight
Power 230V / AC 50/60Hz	Power Cord 12.5m	Cleaning Range 31.4m
360x370x390mm (WxLxH)		Kit AS0 (see page 50)

PPR240 PPR240 HEPA



- Professional accessory kit
- Bumper for wall and door protection
- Long cleaning reach
- Emptying with no dust and no mess
- Plugged cable rewind
- Certified HEPA14 filtration down to 0.3 microns at 99.995% efficiency (PPR240H Only)

9L Capacity	620W Motor	9KG/9.2KG Weight
Power 230V / AC 50/60Hz	Power Cord 12.5m	Cleaning Range 31.4m
360x370x415mm (WxLxH)		Kit AS0 (see page 50)

PPR370 PPR370 HEPA



- Professional accessory kit
- Bumper for wall and door protection
- Long cleaning reach
- Emptying with no dust and no mess
- Plugged cable rewind
- Certified HEPA14 filtration down to 0.3 microns at 99.995% efficiency (PPR370H Only)

15L Capacity	620W Motor	10KG/10.2KG Weight
Power 230V / AC 50/60Hz	Power Cord 12.5m	Cleaning Range 31.4m
360x370x510mm (WxLxH)		Kit AS0 (see page 50)

PPT220/ PPT390

Handy Trolley Design



- Convenient, lift-off storage caddy
- Telescopic handle for ease of transit and storage
- Large rear wheels for ease of use on stairways
- Plugged cable rewind

9L / 15L Capacity	620W Motor	12.3KG / 12.6KG Weight
Power 230V / AC 50/60Hz	Power Cord 12.5m	Cleaning Range 31.4m
355x355x615mm (WxLxH) 390x535x655mm (WxLxH)		Kit AS0 (see page 50)

“Professional, **tough** and **versatile** workhorse full of innovative features.”



PPR240 HEPA

3 Levels of Filtration

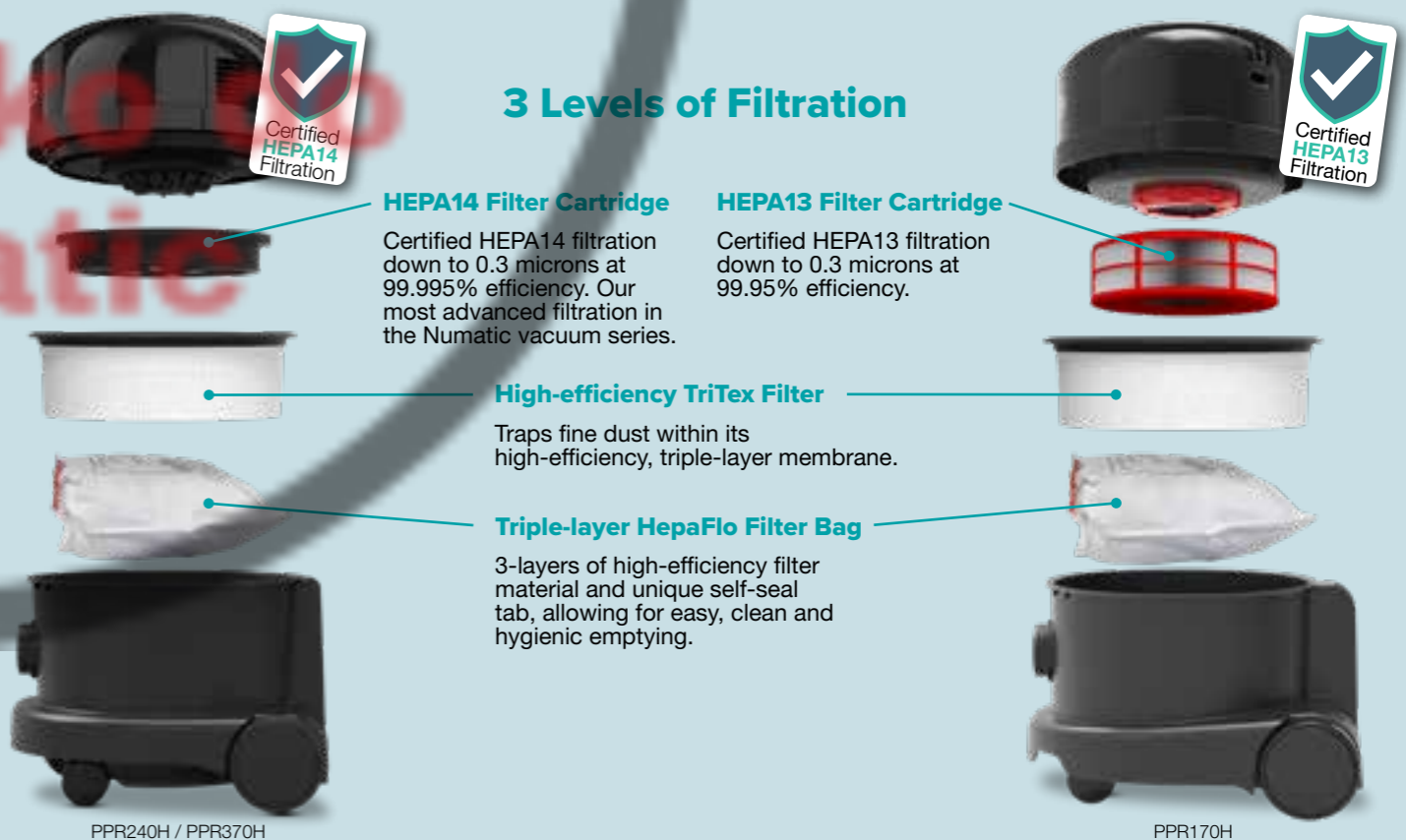

PPR240H / PPR370H

PPR170H

QUICK

Powerful, Cordless, Dust-Free

“All the benefits of **cordless cleaning with no dust, no mess, no fuss.**”

NUMATIC QUICK NQ100



- Advanced user-comfort
- Interchangeable Lithium-Ion battery
- Dust-free emptying
- 2-Year Warranty for commercial use



- 1 & 4 Motorised Brush Head
- 2 Ergonomic Handle for Extra Comfort
- 3 Handy Tools

1L Pod Capacity	300W Motor	140mins Runtime (70mins per battery)	3.2KG Weight
Power 25.2V		Recharge Time 2.5hrs (per battery)	
240x270x1220mm (WxLxH)		Accessories (see page 50)	

Bigger Capacity
Compacts dust inside the pod for more capacity than most leading stick vacuums. With 5 layers of filtration and 99% efficiency at 0.3-0.5 microns.

Comes with 2 batteries; use one, charge one.

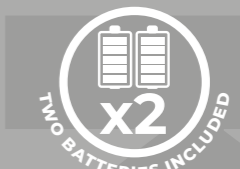

Visit: numatic.com/quick

Figures displayed are with Brush Head off. Run and recharge times may vary dependent on ambient temperature and expected battery ageing.



Pro Cordless Network Increases Productivity

NX300 Pro Cordless Network delivers professional level performance to a versatile and expanding range. Quicker, safer and more convenient, switching to Pro Cordless raises productivity levels, saving time and money.

Why use NX300 Pro Cordless Network?



More Time to Clean



Lower Maintenance



No Cable Trips



Lower Noise



Lower Energy Cost



All Hours Cleaning



Smart Safe Charge System

Built-in battery status and health check safety system. The SoH (State of Health) system monitors multiple parameters ensuring battery safety.



Maximum Energy Deployment

Delivering power from cell to machine with minimum power loss via high-quality welded nickel power rails.

Integrated Heatsink Casing

Quickly and efficiently cools the pack in use, optimising delivery of power.

Integrated Handle

Quickly and easily hot-swap batteries across the Pro Cordless Network.

Integrated Cooling Design

Keeping cool allows maximum power delivery, the clever NX300 pack design eliminates air pockets acting as an insulation, transmitting heat directly out of the pack.

Visit: numatic.com/NX300-pro-cordless

2KG Weight	300Wh Battery Capacity	1hr 80% / 2hrs 100% Charge Time	Up to 2500 Charge Cycles
----------------------	----------------------------------	-------------------------------------------	------------------------------------

Note: Higher ambient temperatures may increase charge time.

DRY Cordless Vacuums



WET Cordless Vacuums



NBV190NX



- High-performance digital motor
- Part of NX300 Pro Cordless Network
- 80mins runtime and 1-hour fast charge

8L Capacity	350W Motor	7.7KG Weight
Power Lithium Battery 36V		Runtime Hi 50 / Lo 80mins
Recharge Time 1hr 80% / 2hrs 100%		Suction H ₂ O 1896mm
340x340x340mm (WxLxH)		Kit AS55 (see page 50)

NBV240NX / NBV240NX HEPA



- High-performance digital motor
- Part of NX300 Pro Cordless Network
- 80mins runtime and 1-hour fast charge
- Bumper for wall and door protection
- Certified HEPA14 filtration down to 0.3 microns at 99.995% efficiency (HEPA model only)

9L Capacity	350W Motor	8.1/8.5KG Weight 240NX/NXH
Power Lithium Battery 36V		Runtime Hi 50 / Lo 80mins
Recharge Time 1hr 80% / 2hrs 100%		Suction H ₂ O 1896mm
360x370x380mm (WxLxH)		Kit AS55 (see page 50)

PBT230NX



- High-performance digital motor
- Part of NX300 Pro Cordless Network
- 80mins runtime and 1-hour fast charge
- Convenient lift-off storage caddy
- Telescopic handle for ease of transit and storage

9L Capacity	350W Motor	10.5KG Weight
Power Lithium Battery 36V		Runtime Hi 50 / Lo 80mins
Recharge Time 1hr 80% / 2hrs 100%		Suction H ₂ O 1896mm
400x450x615mm (WxLxH)		Kit AS55 (see page 50)



1 Easy Battery Change
2 Convenient Lift-off Storage Caddy



Eliminate the risk of slips, trips and falls with no cable, perfect for cleaning up spills in high-traffic areas.



1 MultiFlo Wet Floor Tool
2 Easy Battery Change
3 Rear Dump Hose for Easy Emptying (WBV470NX Only)



- Quick Spill Clean-Ups
- Emergency Leaks
- Entrance Lobbies
- Washrooms & Toilets

WBV370NX / WBV470NX



- Perfect for high-traffic areas
- All-hours cleaning
- 1-hour fast charge
- NX300 Pro Cordless Network

9L/20L Wet Capacity	15L/27L Dry Capacity	9.3/11.9KG Weight
Motor 400W		Power Lithium Battery 36V
Runtime 40mins		Max Airflow 49L/Sec
Max Pump Pressure 145mBar		Recharge Time 1hr 80% / 2hr 100%
Suction H ₂ O 2200mm		Kit AA5 (see page 51)
360x370x480mm (WxLxH) (WBV370NX)		360x450x660mm (WxLxH) (WBV470NX)



3 Rear Dump Hose for Easy Emptying (WBV470NX Only)

NEW PRODUCT **CTB370NX**
 + **Numatic Xtract**



Tackle hard-to-reach areas; clean, scrub and dry floors with the all-in-one solution. With precision spray; scrub, extract and dry heavily soiled areas, emergency spills, corners, edges, and around obstacles.

Eliminate the risk of slips, trips and falls with no cable, perfect for all-hours cleaning in high-traffic areas.



CTB370NX & X-TRACT TOOL



- Perfect for hard-to-reach areas
- Leave floors clean, dry and slip-free
- Tackle wet floors and emergency spills
- 1-hour fast charge
- NX300 Pro Cordless Network

6L Clean Capacity	9L Recovery Capacity	38 MINS Runtime	36V Lithium Battery
Max Airflow 48L/sec		Motor 400W	
Flow Rate 350ml/min		Recharge Time 1hr 80% / 2hr 100%	
Weight 12.9kg		360x375x480mm (WxLxH)	

- 1 Pick-up Floor Tool
- 2 & 3 X-tract Scrub Brush
- 4 Carpet Extraction Tool



Total Performance for Tough to Clean

“The Ultimate All-in-One: Spray, Scrub and Extract with X-tract Tool.”



Compatible with:



The new X-tract tool is fully compatible with every 32mm CT/CTB product.

CTB KITS

Upholstery & Multi-Purpose Kits

Restore carpets, hard floors, upholstery, and valet vehicle interiors with ease.

Multi-Purpose Kit - The complete kit, ready to tackle spills before they turn into stains. Perfect for revitalising carpets, hard floors, and upholstery.

Upholstery Kit - Ready to tackle stubborn stains and spills on furniture or carpets. Perfect for revitalising upholstery and spot-washing carpets.



- 1 Upholstery Extraction
- 2 Carpet Extraction
- 3 Wet Pick-Up



KIT - A42B (B)



KIT - A40B (B)



RUCSAC

Ergonomic Harness



- 1 Adjustable Cushioned Shoulder Straps
- 2 Breathable Mesh Back-Support System
- 3 Supportive Adjustable Chest Strap
- 4 Adjustable Cushioned Waist Strap

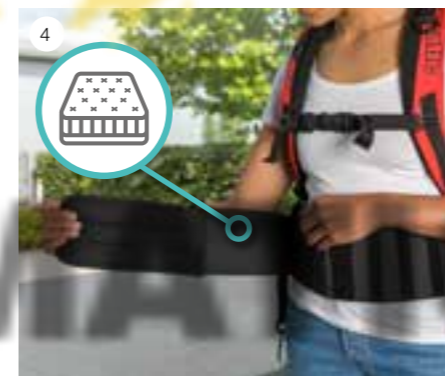

RSB150NX / RSB150NX HEPA



Ergonomically designed with easy-adjust, posture-correcting harness and handy tool storage.



- High-performance digital motor
- Part of NX300 Pro Cordless Network
- 80mins runtime and 1-hour fast charge
- User comfort with ergonomic harness
- Certified HEPA13 filtration down to 0.3 microns at 99.95% efficiency (HEPA model only)

5L Capacity	350W Motor	6.9/7.3KG Weight 150NX/NXH
Power Lithium Battery 36V		Runtime Hi 50 / Lo 80mins
Recharge Time 1hr 80% / 2hrs 100%		Suction H ₂ O 1896mm
330x330x570mm (WxLxH)		Kit AAT30E (see page 51)

MAINS CABLE

Backpacks

Compact, comfortable and convenient, the RSV150 goes wherever you go, making it the perfect cleaning solution for tight and awkward cleaning spaces.



RSV150 / RSV150 HEPA

Increase Cleaning Productivity



- Compact, comfortable and convenient design
- Generous 5L capacity
- Extra-long 15m cable
- User comfort with ergonomic harness
- Emptying with no dust and no mess
- Certified HEPA13 filtration down to 0.3 microns at 99.95% efficiency (HEPA model only)

5L Capacity	620W Motor	5.4/5.8KG Weight 150/150H
Power 230V / AC 50/60Hz	Cleaning Range 36.4m	
Power Cord 15m	Suction H ₂ O 2300mm	
330x330x570mm (WxLxH)		Kit AAT30E (see page 51)

Available on a standard or HEPA model

- Breathable Mesh Panel
- Integrated Hand Control
- Adjustable Cushioned Shoulder Straps

Steel Tops

NQS250 / NQS250B

ALL-STEEL



- All-steel construction, tough and hard-wearing
- Blower facility and diffuser attachment (NQS250B)
- Quick and easy cable replacement
- Plugged cable

9L Capacity	780W Motor	10KG Weight
Power 230V / AC 50/60 Hz	Cleaning Range 26.4m	
Power Cord 10m	Suction H ₂ O 2350mm	
340x340x395mm (WxLxH)		Kit AS0 (see page 50)

Featuring an all-steel head, the Steel Tops range not only provides exceptional strength, it's also quiet and efficient.

NVQ240 / NVQ370 / NVQ380



- Heavy-duty, all-steel power head
- Quick and easy cable replacement
- Plugged cable
- Tough Structofoam drum construction (NVQ380 Only)

9L / 15L / 15L Capacity	780W Motor	9.65KG / 10KG / 11.35KG Weight	
Power 230V / AC 50/60Hz	Power Cord 10m	Cleaning Range 26.4m	Suction H ₂ O 2300mm
360x370x415mm (240), 355x355x485mm (370), 355x355x485mm (380) (WxLxH)			Kit AS0 (see page 50)

MicroLine Advanced Filtration

High-efficiency 5-stage pre and post-motor HEPA13 filtration conforming to ISO 14644-1 Class 5 cleanroom classification.



PPH320 HEPA Filtration



- Certified HEPA13 filtration down to 0.3 microns at 99.95% efficiency
- Emptying with no dust and no mess
- Quick and easy cable replacement
- Plugged cable rewind

12L Capacity	620W Motor	10KG Weight
Power 230V / AC 50/60 Hz	Cleaning Range 31.4m	
Power Cord 12.5m	Suction H ₂ O 2300mm	
360x370x415mm (WxLxH)		Kit AS0 (see page 50)

CRQ370 Clean Room Filtration



- Certified HEPA13 filtration down to 0.3 microns at 99.95% efficiency
- Advanced 5-Stage filtration system
- Conforms to ISO 14644-1 Class 5 classification
- Quick and easy cable replacement
- Emptying with no dust and no mess

10L Capacity	960W Motor	11.5KG Weight
Power 230V / AC 50/60 Hz	Cleaning Range 26.4m	
Power Cord 10m	Suction H ₂ O 2300mm	
355x355x485mm (WxLxH)		Kit A1 (see page 50)



AIRCRAFT

The Pro Harness offers enhanced operator comfort, increasing cleaning efficiency, capability and productivity, without any uncomfortable distractions.



RSAV130 Enhanced Harness



- Aircraft specification
- User-comfort with ergonomically designed harness
- High-efficiency filtration

6L Capacity	960W Motor	6.1KG Weight
Power 110V / AC 400Hz	Cleaning Range 43.2m	
Power Cord 18.2m	Suction H ₂ O 2400mm	
250x360x440mm (WxLxH)		Kit A30A (see page 51)



DRY Big Capacity

Power and performance in industrial terms needs to be matched to long-life, reliability and user-satisfaction.

NVQ570/ NVDQ570



- Tough Structofoam construction
- Directional castors for ease of transit
- Quick and easy cable replacement

23L Capacity	960W Motor (NVQ)	960Wx2 Motor (NVDQ)
Power 230V / AC 50/60 Hz	Cleaning Range 26.8m	
Weight 16.5kg (NVQ)	Weight 18.7kg (NVDQ)	
Power Cord 10m	Suction H ₂ O 2300mm	
415x415x645mm (WxLxH)		Kit BS2 (see page 51)

NVQ900/ NVDQ900



- Tough Structofoam construction
- Pull handle for ease of transit
- Large rear wheels provide excellent mobility
- Quick and easy cable replacement

40L Capacity	960W Motor (NVQ)	960Wx2 Motor (NVDQ)
Power 230V / AC 50/60 Hz	Cleaning Range 28.8m	
Weight 25.2kg (NVQ)	Weight 27.7kg (NVDQ)	
Power Cord 10m	Suction H ₂ O 2300mm	
490x800x880mm (WxLxH)		Kit BS2 (see page 51)

- 1 Large Rear Wheels for Excellent Mobility
- 2 High-efficiency ProFlo Dry Floor Tool



- 1 High-efficiency Hard Floor Tool
- 2 Easily Remove Bags & Filters

AVQ250

ALL-STEEL



- All-steel construction, tough and hard-wearing
- MicroTec noise reduction system
- Aircraft specification
- Plugged cable

9L Capacity	960W Motor	10.6KG Weight
Power 110V / AC 400Hz	Cleaning Range 43.2m	
Power Cord 18.2m	Suction H ₂ O 2500mm	
340x340x395mm (WxLxH)		Kit AS4 (see page 50)

AVQ380

Tough Structofoam



- Heavy-duty, all-steel power head
- MicroTec noise reduction system
- Aircraft specification
- Plugged cable

15L Capacity	960W Motor	11.8KG Weight
Power 110V / AC 400Hz	Cleaning Range 43.2m	
Power Cord 18.2m	Suction H ₂ O 2500mm	
355x355x485mm (WxLxH)		Kit AS4 (see page 50)

Structofoam

Cellular structure provides strength and flexibility

- Incredibly tough and long-lasting
- Hard-wearing and chemical-resistant
- Exceptional strength-to-weight ratio
- Lightweight and ergonomic structure

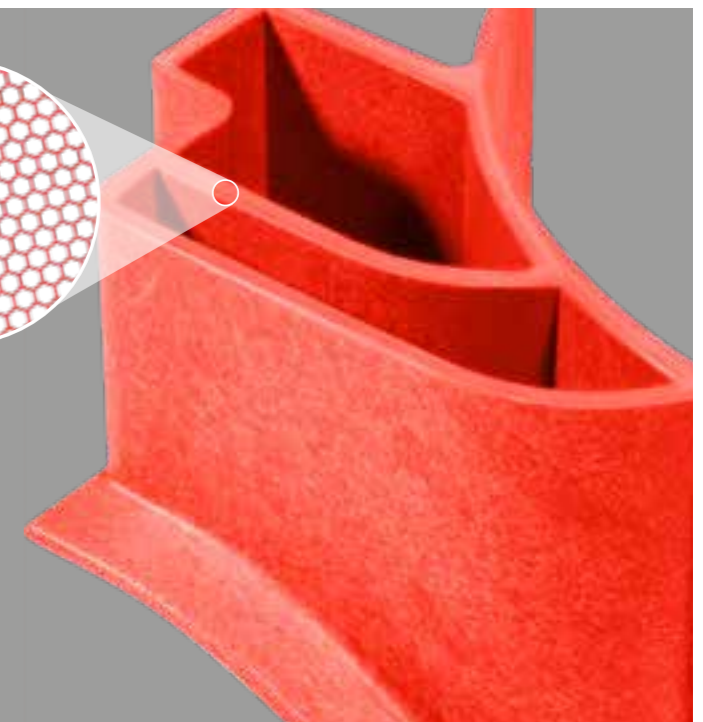
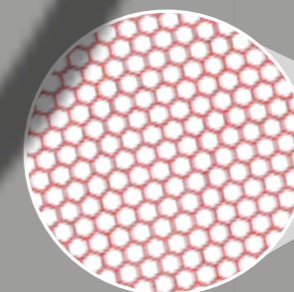

WET

Enhanced with increased efficiency in wet pick-up.

- Powerful & Professional Performance
- Built to Last
- Easy, Clean & Safe Emptying

WV370



- Compact and easy to store
- Lightweight with easy carry handle
- Convenient emptying

9L Capacity	1000W Motor	8.6KG Weight
Power 230V / AC 50/60Hz	Cleaning Range 26.8m	
Power Cord 10m	Suction H ₂ O 2400mm	
360x370x510mm (WxLxH) Kit AA5 (see page 51)		

WV470

Fold Down Transit Handle



- Compact and capable
- Convenient folding transit handle
- Large rear wheels for ease of movement

20L Capacity	1000W Motor	9.6KG Weight
Power 230V / AC 50/60Hz	Cleaning Range 26.8m	
Power Cord 10m	Suction H ₂ O 2400mm	
350x430x710mm (WxLxH) Kit AA5 (see page 51)		

WV570 / WVD570



- Easy emptying
- Heavy-duty Structofoam construction
- Convenient cable replacement system

15L Capacity	1000W Motor (WV)	1000Wx2 Motor (WVD)
Power 230V / AC 50/60Hz	Cleaning Range 26.8m	
Weight 16.3kg (WV)	Weight 18.5kg (WVD)	
Power Cord 10m	Suction H ₂ O 2400mm	
415x415x645mm (WxLxH) Kits (WV) AA5 / (WVD) BS7 (see page 51)		

WV900 / WVD900



- Easy empty tip handle
- Heavy-duty Structofoam construction
- Convenient cable replacement system

32L Capacity	1000W Motor (WV)	1000Wx2 Motor (WVD)
Power 230V / AC 50/60Hz	Cleaning Range 26.8m	
Weight 25.2kg (WV)	Weight 28kg (WVD)	
Power Cord 10m	Suction H ₂ O 2400mm	
490x800x880mm (WxLxH) Kits (WV) AA5 / (WVD) BS7 (see page 51)		

Auto Empty

Continuous pumping operation precisely where you need it.

Auto Pump (AP) enables for continuous pumping operations and maximum cleaning productivity.

Image for illustration purposes only.



WV570



WV1800DH / WVD1800DH / WVD1800AP



- Easy emptying with rear dump hose
- Heavy-duty Structofoam construction
- Rear Auto Pump for continuous water extraction (AP model only)
- Convenient cable replacement system

70L Capacity	1000W Motor (WV)	1000Wx2 Motor (WVD)
Power 230V / AC 50/60Hz		
Power Cord 10m	Weight 31.5kg (WV1800DH)	
Cleaning Range 26.8m	Weight 34kg (WVD1800DH)	
Suction H ₂ O 2400mm	Weight 40.4kg (WVD1800AP)	
684x785x935mm (WxLxH) Kit BS7 (see page 51)		

WVD2000DH / WVD2000AP



- Robust steel chassis for ease of transit
- Easy emptying with rear dump hose
- Heavy-duty Structofoam head construction
- Convenient cable replacement system
- Rear Auto Pump for continuous water extraction (AP model only)

70L Capacity	1000Wx2 Motor
Power 230V / AC 50/60Hz	Weight 28.9kg (WVD2000DH)
Power Cord 10m	Weight 36.4kg (WVD2000AP)
Cleaning Range 26.8m	Suction H ₂ O 2400mm
640x530x970mm (WxLxH) Kit BS7 (see page 51)	



- Auto Pump for Continuous Water Extraction
- High-efficiency ProFlo Wet Floor Tool

WET & DRY

Effortlessly switch from dry to wet with no hassle.

- Wet & Dry System
- High-efficiency
- A Tool for Every Job

The unique high-efficiency, dual washable filter system in the CV range enables the user to switch from dry to wet pick-up without the hassle of changing filters or kits.

CV570 / CVD570



- Wet and dry pick-up
- Washable filter system
- Heavy-duty Structofoam construction

13L Capacity	1000W Motor (CV)	1000Wx2 Motor (CVD)
Power 230V / AC 50/60Hz	Cleaning Range 26.8m	
Power Cord 10m	Weight 16.3kg (CV)	
Suction H ₂ O 2400mm	Weight 18.5kg (CVD)	
415x415x645mm (WxLxH)	Kit BS8 (see page 51)	

CV900 / CVD900



- Wet and dry pick-up
- Washable filter system
- Heavy-duty Structofoam construction
- Convenient emptying

30L Capacity	1000W Motor (CV)	1000Wx2 Motor (CVD)
Power 230V / AC 50/60Hz	Cleaning Range 26.8m	
Power Cord 10m	Weight 25.2kg (CV)	
Suction H ₂ O 2400mm	Weight 27.7kg (CVD)	
490x800x880mm (WxLxH)	Kit BS8 (see page 51)	

Tipping Handle for Easy Emptying (900 model only)



- 1 Dry Floor Tool Pick-up
- 2 Clean, Dry Floors Again & Again
- 3 Wet & Dry System
- 4 Easy Emptying



EXTRACTION

The All-Purpose 4-in-1 carpet and upholstery cleaners.

- Ready for Anything
- Powerful Cleaning Results
- Tank Within a Tank

The compact CleanTecs provide the combination of a PowerFlo liquid pump supply and efficient wet pick-up facility, all incorporated in one unit.

CT370



- Wet, spray extraction carpet cleaning, upholstery cleaning and car valeting
- Compact and easy to store
- Convenient emptying

15L/9L Capacity Dry/Wet	1000W Motor	11.2KG Weight
Power 230V / AC 50/60Hz	Cleaning Range 26.8m	
Power Cord 10m	Suction H ₂ O 2400mm	
360x370x510mm (WxLxH)	Kit A40A (see page 51)	

CT470



- Wet, spray extraction carpet cleaning, upholstery cleaning and car valeting
- Compact and easy to store
- Large rear wheels and folding handle for ease of transit

27L/20L Capacity Dry/Wet	1000W Motor	14.4KG Weight
Power 230V / AC 50/60Hz	Cleaning Range 26.8m	
Power Cord 10m	Suction H ₂ O 2400mm	
350x430x710mm (WxLxH)	Kit A40A (see page 51)	

Ergonomic convenient folding handle, large rear wheels and directional castors ease stability during transit.



- 1 Upholstery Extraction Tool
- 2 Fishtail Extraction Tool
- 3 Convenient Carry Handle



EXTRACTION

The All-Purpose 4-in-1 carpet and upholstery cleaners.

- Ready for Anything
- Powerful Cleaning Results
- Tank Within a Tank

CT570 / CTD570



- Wet, spray extraction carpet cleaning, upholstery cleaning and car valeting
- Heavy-duty Structofoam construction
- Convenient cable replacement system

23L/15L Capacity Dry/Wet	1000W Motor (CT)	1000Wx2 Motor (CTD)
Power 230V / AC 50/60Hz	Cleaning Range 26.8m	
Power Cord 10m	Weight 18.9kg (CT)	
Suction H ₂ O 2400mm	Weight 20kg (CTD)	
415x415x645mm (WxLxH)	Kit A41A (see page 51)	

CT900 / CTD900



- Wet, spray extraction carpet cleaning, upholstery cleaning and car valeting
- Easy emptying with tip handle
- Heavy-duty Structofoam construction

40L/32L Capacity Dry/Wet	1000W Motor (CT)	1000Wx2 Motor (CTD)
Power 230V / AC 50/60Hz	Cleaning Range 26.8m	
Power Cord 10m	Weight 25.3kg (CT)	
Suction H ₂ O 2400mm	Weight 27.7kg (CTD)	
490x800x880mm (WxLxH)	Kit A41A (see page 51)	



“The PowerFlo pump system injects the cleaning solution deep into the carpets in a continuous deep cleaning cycle.”

- 1 Ideal for Car Valeting
- 2 Upholstery Extraction Tool



TriJet Carpet Cleaning

- Uniform fluid distribution
- Easy pull-back movement
- Heavy-duty, Aluminium construction

NHL15



- Carpet cleaning and upholstery / spot cleaning tools
- Uniform fluid distribution with TriJet carpet extraction
- Hi-Lo system for pressure when you need it

15L Capacity	1000W Motor	35KG Weight
Power 230V / AC 50/60Hz	Cleaning Range 26.8m	
Power Cord 10m	Suction H ₂ O 2400mm	
435x425x725mm (WxLxH)	Kit BS27 (see page 51)	



- 1 & 2 High-performance, TriJet Carpet Extraction Tool
- 3 Upholstery & Spot Cleaning Extraction Tool

CLEANCARE KITS

DRY KITS

AS0 - 903146



601008	Stainless Steel Extension Tube (x2)
601052	Stainless Steel Tube Bend with NPC Volume Control
915909	2.2m FloMax Conical Hose
912358	280mm ProFlo Combination Floor Tool
601141	Double Taper Hose / Tool Adaptor
601142	240mm Crevice Tool
601144	65mm Soft Dusting Tool
601145	150mm Upholstery Tool
601146	150mm Slide-on Brush for Upholstery Tool

A1 - 607301



601008	Stainless Steel Extension Tube (x2)
601052	Stainless Steel Tube Bend with NPC Volume Control
915907	2.2m Parallel Hose
902071	300mm Combination Floor Tool
601141	Double Taper Hose / Tool Adaptor
601142	240mm Crevice Tool
601144	65mm Soft Dusting Brush
601145	150mm Upholstery Tool
601146	150mm Slide-on Brush for Upholstery Tool

HEPAFLO FILTER BAGS



604011	10 x (NVM-1AH) HepaFlo Dust Bags
604048	Master Carton 16 x 10 (NVM-1AH)
604015	10 x (NVM-1CH) HepaFlo Dust Bags
604615	Master Carton 8 x 10 (NVM-1CH)
604016	10 x (NVM-2BH) HepaFlo Dust Bags
604816	Master Carton 16 x 10 (NVM-2BH)
604019	10 x (NVM-4BH) HepaFlo Dust Bags
604819	Master Carton 6 x 10 (NVM-4BH)

All Numatic vacuum bags are 100% carbon balanced.

SPECIALISED KITS

A30A - 607817



914979	1.2m RSAV Threaded Hose
601008	Stainless Steel Extension Tube (x2)
601052	Stainless Steel Tube Bend with NPC Volume Control
902071	300mm Combination Floor Tool
601141	Double Taper Hose / Tool Adaptor
601144	65mm Soft Dusting Brush

AAT30E - 919897



914980	1.2m RSB / RSV150 Hose
915195	Aluminium Tube Bend with NPC Volume Control
914759	Aluminium Telescopic Wand
902923	270mm ProFlo Combination Floor Tool
601141	Double Taper Hose / Tool Adaptor
601144	65mm Soft Dusting Brush

BS2 - 916230

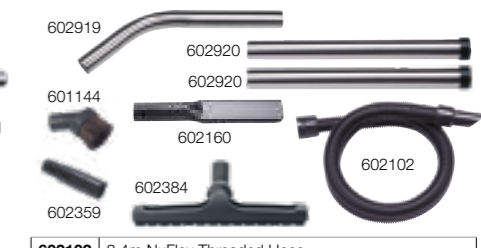

602102	2.4m NuFlex Threaded Hose
602919	Stainless Steel Tube Bend
602920	Stainless Steel Extension Tube (x2)
602384	400mm ProFlo Brush / Rubber Floor Tool
601144	65mm Soft Dusting Brush
602359	38/32mm Adaptor
602160	305mm ABS Crevice Tool

NUMATIC QUICK BOXED ACCESSORIES

915242	UK Plug and Cable
915243	EURO Plug and Cable
915170	Quick Battery
915351	Wall Mount
915353	Extended-Use Handle
917409	Floor Tool
915352	Crevice & Combi Tool Pack
915358	Brush Bar
915527	Mini Motorised Tool
915356	Wand
915632	Handheld Unit
915269	Quick Pods (Pack of 10 WW)
914593	Vanilla Scent Pods (Pack of 10)
915350	Passion Fruit Scent Pods (Pack of 10)
915674	Rose Scent Pods (Pack of 10)
915357	Scent Pod Cap



WET KITS

AA5 - 921246

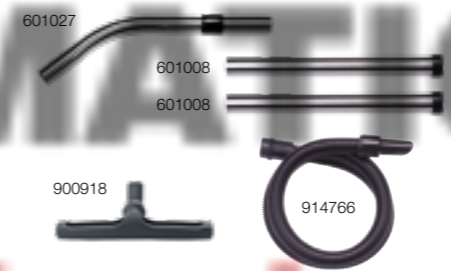

914766	2.5m Bayonet Hose
601027	Stainless Steel Bend with (Black) Volume Control
601008	Stainless Steel Extension Tube (x2)
601182	370mm Wet Pick-up Floor Tool

BS7 - 607249

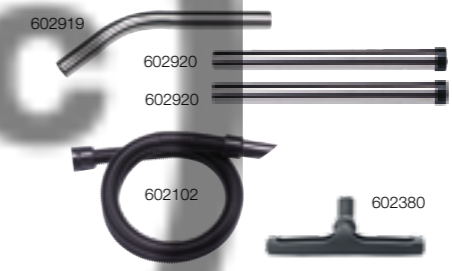

602102	2.4m NuFlex Threaded Hose
602919	Stainless Steel Tube Bend
602920	Stainless Steel Extension Tube (x2)
602380	400mm ProFlo Wet Pick-up Floor Tool

BS8 - 607241

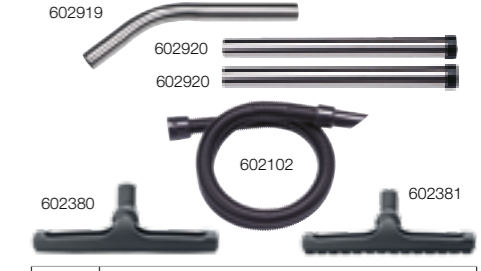

602102	2.4m NuFlex Threaded Hose
602919	Stainless Steel Tube Bend
602920	Stainless Steel Extension Tube (x2)
602380	400mm ProFlo Wet Pick-up Floor Tool
602381	400mm ProFlo Dry Pick-up Floor Tool

NX300

NX300 ACCESSORIES

913686	NX300 Battery
911334	NX300 Charging Dock
910820	NX300 Dual Charging Dock
NX300 Mains Cable for Charging Docks	
912365	UK
912361	EURO
912364	SWISS
912360	AUS/NZ
912362	USA
912363	S.AFRICA
913041	JPN
NX300 Dual Charging Dock with Mains Cable	
915748	UK
915749	EURO
915750	SWISS
915751	AUS/NZ
915752	USA
915753	S.AFRICA
915754	JPN



SPECIALISED KITS

AS55 - 916028

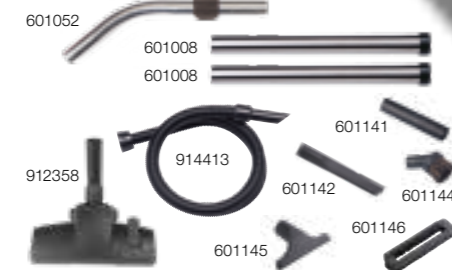

914413	2m Parallel Hose
601008	Stainless Steel Extension Tube (x2)
601052	Stainless Steel Tube Bend with NPC Volume Control
912358	280mm ProFlo Combination Floor Tool
601141	Double Taper Hose / Tool Adaptor
601142	240mm Crevice Tool
601144	65mm Soft Dusting Brush
601145	150mm Upholstery Tool
601146	150mm Slide-on Brush for Upholstery Tool

AS4 - 900961



601008	Stainless Steel Extension Tube (x2)
601052	Stainless Steel Tube Bend with NPC Volume Control
914411	2m FloMax Conical Hose
601430	290mm FreeFlo Floor Tool
601141	Double Taper Hose / Tool Adaptor
601142	240mm Crevice Tool
601144	65mm Soft Dusting Brush
601145	150mm Upholstery Tool
601146	150mm Slide-on Brush for Upholstery Tool

EXTRACTION KITS

A40A - 607147

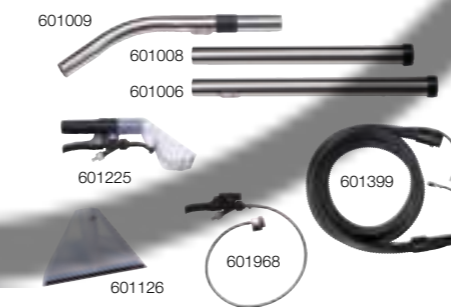

601399	4m CleanTec Extraction Hose
601009	Stainless Steel Extraction Trigger Bend Tube
601006	Stainless Steel Lower Tool Extraction Tube
601008	Stainless Steel Extension Tube
601126	275mm Fishtail Extraction Tool
601225	100mm Upholstery Extraction Tool
601968	CleanTec Trigger Valve and Spray Tube

A41A - 607148



601399	4m CleanTec Extraction Hose
601009	Stainless Steel Extraction Trigger Bend Tube
601006	Stainless Steel Lower Tool Extraction Tube
601008	Stainless Steel Extension Tube
601423	275mm Aluminium Extraction Tool
601225	100mm Upholstery Extraction Tool
601968	CleanTec Trigger Valve and Spray Tube

BS27 - 607248



602399	4m HiLo CleanTec Extraction Hose
602922	Stainless Steel Extraction Tube Bend
602920	Stainless Steel Extension Tube (x2)
602937	145mm Stainless Steel Extension Tube
602200	CleanTec TriJet Extraction Floor Tool
602300	CleanTec TriJet Trigger and Solution Tube
602225	100mm Upholstery Extraction Tool

ProCare

Advanced, professional cleaning for the collection and control of dust and hazardous substances.

Contents

NuTec Industrial	54
Anti-Static	54
DustCare	54
M-Class	55
TradeLine	56-57, 61
H-Class	58-59
ProCare Kits	60-61

EURO-MATIC

wszystko do Numatic



Page 59 HZC390S



Page 54 NTD750

“Delivering enhanced filtration where it is needed most.”



NEW
PRODUCT

Page 56 TRM240

INDUSTRIAL VACUUMS

NuTec Industrial

NTD750



NTD2003



NTT2003



- TwinFlo 2-motor Structofoam power head
- Industrial vacuum suitable for many applications including; boiler cleaning, floor cleaning, metalworking, dirt, dust or debris, and more

- Big capacity machine with TwinFlo 2-motor Structofoam power head
- Stainless Steel container with heavy-duty chassis

- Triplex power head in all-steel construction
- Mounted on an all-steel heavy-duty chassis, easily demounted for emptying

35L Capacity	1000Wx2 Motor	20.8KG Weight
Power 230V / AC 50/60Hz	Cleaning Range 26.8m	
Power Cord 10m	Suction H ₂ O 2400mm	
510x510x960mm (WxLxH) Kit BB5 (see page 60)		

60L Capacity	1000Wx2 Motor	30.2KG Weight
Power 230V / AC 50/60Hz	Cleaning Range 26.8m	
Power Cord 10m	Suction H ₂ O 2400mm	
560x660x1145mm (WxLxH) Kit BB5 (see page 60)		

80L Capacity	1000Wx3 Motor	36KG Weight
Power 230V / AC 50/60Hz	Cleaning Range 31.8m	
Power Cord 12.5m	Suction H ₂ O 2400mm	
560x660x1075mm (WxLxH) Kit BB5 (see page 60)		

M-Class

**MES570
MES570A
MED570
MED570A**



Power Outlet Socket (Optional)



- M-Class Compliant – IEC/EN 60335-2-69
- High-efficiency internal AirFlo system with low flow and full bag indicator
- TriTex filtration and HepaFlo filter bag
- Plugged easy cable replacement system
- Optional Auto Operation Power Outlet Socket

**MES900
MES900A
MED900
MED900A**



- M-Class Compliant – IEC/EN 60335-2-69
- High-efficiency internal AirFlo system with low flow and full bag indicator
- TriTex filtration and HepaFlo filter bag
- Plugged easy cable replacement system
- Optional Auto Operation Power Outlet Socket

23L Capacity	620W Motor (MES)	620Wx2 Motor (MED)
Power Outlet Socket Optional (MES570A/MED570A)		
Weight 19.2/20.8kg (MES/MED)	Weight 19.3/20.9kg (MES(A)/MED(A))	
Power 230V / AC 50/60Hz	Cleaning Range 30m	
Power Cord 10m	Suction H ₂ O 2300mm	
415x415x780mm (WxLxH) Kit AS50 (see page 60)		

40L Capacity	620W Motor (MES)	620Wx2 Motor (MED)
Power Outlet Socket Optional (MES900A/MED900A)		
Weight 25.1/27.6kg (MES/MED)	Weight 25.2/27.7kg (MES(A)/MED(A))	
Power 230V / AC 50/60Hz	Cleaning Range 30m	
Power Cord 10m	Suction H ₂ O 2300mm	
490x800x945mm (WxLxH) Kit AS50 (see page 60)		

- 1 Low Flow Indicator
- 2 Plugged Replacement
- 3 Power Outlet Socket



Anti-Static

HAS750



- H13 (EN1822)
- Full anti-static specification in machine and accessories
- The non-conductive specification continually discharges the static build up during use

35L Capacity	960W Motor	23KG Weight
Power 230V / AC 50/60Hz	Cleaning Range 25.6m	
Power Cord 8.5m	Suction H ₂ O 2500mm	
510x510x960mm (WxLxH) Kit HAS (see page 61)		

DustCare

NES570/A / NED570/A



- Optional Auto Operation Power Outlet Socket
- Low flow and full bag indicator
- High-efficiency internal AirFlo system

23L Capacity	620W Motor (NES)	620Wx2 Motor (NED)
Power Outlet Socket Optional (NES570A / NED570A)	Weight 18/20kg (NES/NED)	
Power 230V / AC 50/60Hz	Cleaning Range 26.8m	
Power Cord 10m	Suction H ₂ O 2300mm	
415x415x645mm (WxLxH) Kit BB5 (see page 60)		

NES900/A / NED900/A



Power Outlet Socket (Optional)

- Optional Auto Operation Power Outlet Socket
- Low flow and full bag indicator
- High-efficiency internal AirFlo system

40L Capacity	620W Motor (NES)	620Wx2 Motor (NED)
Power Outlet Socket Optional (NES900A / NED900A)	Weight 25/29kg (NES/NED)	
Power 230V / AC 50/60Hz	Cleaning Range 26.8m	
Power Cord 10m	Suction H ₂ O 2300mm	
490x800x880mm (WxLxH) Kit BB5 (see page 60)		

L, M, & H-Class

What type of vacuum extractor do you need?

L CLASS	General dust, mixed dust, gypsum
M CLASS	Soft / hardwood, silica, masonry, paint, plastic, ceramic
H CLASS	Asbestos

For guidance only. Find out more at hse.gov.uk/construction



Around **12,000** workers die from illnesses caused by inhaling hazardous dust particles each year in the UK. Construction workers are at higher risk from the dust particles they breathe in. **Protect DON'T Neglect.**



COMPLIANCE Meets Clean

Delivering outstanding performance, value and reliability with M-Class filtration.

The NEW TRM240 joins the TradeLine range, offering M-Class compliant cleaning in a compact, affordable design. It's ideal for construction and industrial environments with medium hazard dust such as soft/ hardwood, silica, masonry, paint, plastic, ceramic, brick dust, and concrete. This durable Numatic vacuum ensures high-performance and user-safety.



1 TradeLine TRM240
2 Safety Cap
3 10m Hi-Vis Cable
4 Easy, Clean & Safe Emptying
5 On-board Tool Storage

Watch the full video here:



1 Plugged Cable for Easy Replacement (TRM240P)



- M-Class Compliant - IEC/EN 60335-2-69
- Lightweight and easy to use
- Powerful and efficient
- Washable H14 filter
- 10m hi-vis cable

9L Capacity	620W Motor	8.1KG Weight
Power 230V / AC 50/60Hz	Cleaning Range 27.4m	
Power Cord 10m	Suction H ₂ O 2300mm	
360x370x415mm (WxLxH)		Kit AS76 (see page 60)



- M-Class Compliant - IEC/EN 60335-2-69
- Lightweight and easy to use
- Powerful and efficient
- Washable H14 filter
- Plugged easy cable replacement system

9L Capacity	620W Motor	8.1KG Weight
Power 230V / AC 50/60Hz	Cleaning Range 32.8m	
Power Cord 12.5m	Suction H ₂ O 2300mm	
360x370x415mm (WxLxH)		Kit AS10 (see page 60)

*Note: Not standard UK model, please contact your Numatic representative for information.

3 Levels of Filtration

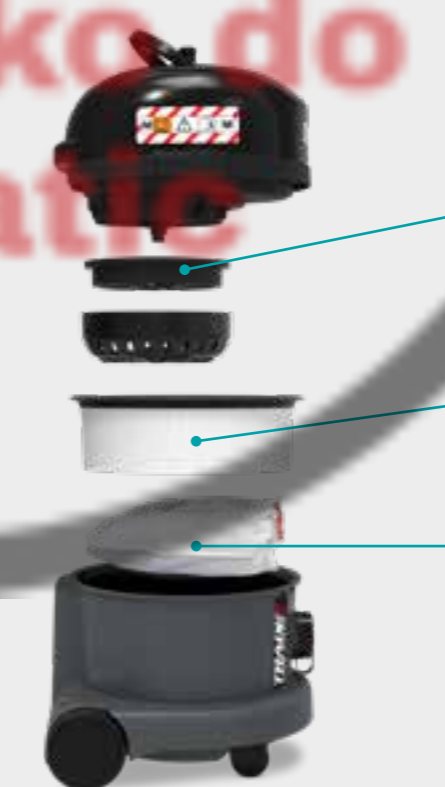

HEPA14 Filter Cartridge

Certified HEPA14 filtration down to 0.3 microns at 99.995% efficiency. Our most advanced filtration in the Numatic vacuum series.

High-efficiency TriTex Filter

Traps fine dust within its high-efficiency, triple-layer membrane.

Triple-layer HepaFlo Filter Bag

3-layers of high-efficiency filter material and unique self-seal tab, allowing for easy, clean and hygienic emptying.

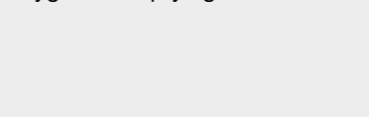

1 Plugged Cable for Easy Replacement (TRM240P)



Built for the Tough Stuff

Compact, tough, and highly mobile, the TradeLine 390 vacuums combine a specialist on-tool extractor with a big clean-up machine to cover almost any application.

TEL390S



- L-Class Compliant - IEC/EN 60335-2-69
- Huge cleaning reach, with 10m cable and 2.8m hose
- Large rear wheels for ease of transit
- Tough, durable and built to last

18L Capacity	620W Motor	10.8KG Weight
Power 230V / AC 50/60Hz	Cleaning Range 28m	
Power Cord 10m	Suction H ₂ O 2500mm	
400x450x600mm (WxLxH)		Kit AS10 (see page 60)

TEM390A



- M-Class Compliant - IEC/EN 60335-2-69
- Huge cleaning reach, with 10m cable and 2.8m hose
- Large rear wheels and extending pull handle for ease of transit
- 2200W Automatic power take-off

18L Capacity	620W Motor	14.3KG Weight
Power 230V / AC 50/60Hz	Cleaning Range 28m	
Power Cord 10.0m	Suction H ₂ O 2500mm	
400x450x1010mm (WxLxH)		Kit AS10 (see page 60)

H CLASS H-CLASS

H-Class equipment is the legal requirement when working with high-risk, non-explosive, hazardous dusts and materials, including asbestos.

Designed, engineered and built with the tradesman in mind, the HZC390 offers a safe and convenient solution for those whose work brings them into infrequent contact with hazardous dusts and materials.

HZ370



- H-Class Compliant - IEC/EN 60335-2-69
- TriTex filtration and HepaFlo filter bags
- Compact and ready to go
- Powerful, long-life 960W motor

15L Capacity	960W Motor	11KG Weight
Power 230V / AC 50/60Hz		Cleaning Range 26.8m
Power Cord 10m		Suction H ₂ O 2500mm
355x355x570mm (WxLxH)		Kit AA18 (see page 60)

HZ390S / L

Extending Pull Handle (HZ390L)



- H-Class Compliant - IEC/EN 60335-2-69
- TriTex filtration and HepaFlo filter bags
- Compact and ready to go
- Large rear wheels and pull handle

18L Capacity	960W Motor	11.2/12.6KG Weight (S/L)
Power 230V / AC 50/60Hz		
Power Cord 10m		Cleaning Range 26.8m
Suction H ₂ O 2500mm		Kit AA18 (see page 60)
400x450x600mm (S) (WxLxH)	400x450x1010mm (L) (WxLxH)	



HZ570 / HZD570



- H-Class Compliant - IEC/EN 60335-2-69
- All-steel head construction
- Plugged easy cable replacement system

23L Capacity	960W Motor (HZ)	960Wx2 Motor (HZD)
Power 230V / AC 50/60Hz		
Power Cord 10m		Suction H ₂ O 2500mm
HZ570		HZD570
Weight 18kg	Weight 20kg	
Cleaning Range 26.8m	Cleaning Range 26.8m	
Kit AA19 (see page 54)	Kit BB19 (see page 60)	
415x415x746mm (WxLxH)		

HZ900 / HZD900



- H-Class Compliant - IEC/EN 60335-2-69
- All-steel head construction
- Plugged easy cable replacement system

40L Capacity	960W Motor (HZ)	960Wx2 Motor (HZD)
Power 230V / AC 50/60Hz		
Power Cord 10m		Suction H ₂ O 2500mm
HZ900		HZD900
Weight 28kg	Weight 30kg	
Cleaning Range 26.8m	Cleaning Range 26.8m	
Kit AA20 (see page 54)	Kit BB20 (see page 60)	
490x800x880mm (WxLxH)		



- 1 Easy, Clean & Safe Emptying
- 2 All-terrain Large Rear Wheels
- 3 Stainless Steel Gulper / Scraper Tool
- 4 Transit Safety Cap

HZC390S / HZC390L

Extending Pull Handle (HZC390L)



- H-Class Compliant - IEC/EN 60335-2-69
- Disposable filter cartridge
- Quick, simple and safe emptying
- Compact and ready to go

13L Capacity	1000W Motor	12.2/13KG Weight (S/L)
Power 230V / AC 50/60Hz		
Power Cord 10m		Cleaning Range 26.8m
Suction H ₂ O 2500mm		Kit AA16 (see page 60)
400x450x600mm (S) (WxLxH)	400x450x1010mm (L) (WxLxH)	

RHB150NX



- H-Class Compliant - IEC/EN 60335-2-69
- Tackle hard-to-reach areas
- Perfect for high-level cleaning
- Part of NX300 Pro Cordless Network
- 50mins runtime and 1-hour fast charge

5L Capacity	350W Motor	7.2KG Weight
Power Lithium Battery 36V		Runtime 50mins
Recharge Time 1hr 80% / 2hrs 100%		Suction H ₂ O 1896mm
330x330x570mm (WxLxH)		Kit AA21 (see page 61)

HZC Cartridge

All dust is safely contained within a sealed, HEPA13 filter cartridge, so you can breathe easy.



Watch the full video here:



HZC DISPOSABLE CARTRIDGE



13L Capacity	2.9KG Weight
HEPA H13 Filter Conforms to EN1822	
330x330x390mm (WxLxH)	Fits all HZC machines



- 1 **All-Steel Head**
Heavy-duty power head.
- 2 **HZC Disposable Cartridge**
HEPA H13 Filter conforms to EN1822. Fits all HZC machines.
- 3 **Robust Drum**
Tough drum construction with all-terrain large rear wheels for stairs and uneven surfaces.



RHB150NX

PROCARE KITS

AA16 - 909539



915907	2.2m Parallel Hose
601142	240mm Crevice Tool
602161	152mm Rubber Brush with Soft Bristles
602159	38 / 32mm Adaptor
601144	65mm Soft Dusting Brush
601141	Double Taper Hose / Tool Adaptor
601917	280mm Stainless Steel Gulper / Scraper Tool (32mm)

AA18 - 902756



915907	2.2m Parallel Hose
601142	240mm Crevice Tool
602161	152mm Rubber Brush with Soft Bristles
602159	38 / 32mm Adaptor
601144	65mm Soft Dusting Brush
601141	Double Taper Hose / Tool Adaptor
601917	280mm Stainless Steel Gulper / Scraper Tool (32mm)
908229	Roll of 10 x 120L Waste Bags

AA19 - 902757 / AA20 - 902758



915907	2.2m Parallel Hose (AA19 HZ570)
914413	2m Parallel Threaded Hose (AA20 HZ900)
604017	10 x (NVM-3BH) HepaFlo Dust Bags (AA19 HZ570)
604019	10 x (NVM-4BH) HepaFlo Dust Bags (AA20 HZ900)
601142	240mm Crevice Tool
602161	152mm Rubber Brush with Soft Bristles
602159	38 / 32mm Adaptor
601144	65mm Soft Dusting Brush
908229	Roll of 10 x 120L Waste Bags
601141	Double Taper Hose / Tool Adaptor
601917	280mm Stainless Steel Gulper / Scraper Tool (32mm)
604116	Primary PermaTex Filter

HAS - 607661



602111	2.6m ATX Hose
602112	400mm ATX Widetrack Brush Tool
602919	Stainless Steel Tube Bend
602929	ATX Stainless Steel Extension Tube (x2)
602125	130mm ATX Conductive Rubber Gulper Tool
604019	10 x (NVB-4BH) HepaFlo Dust Bags
908229	Roll of 10 x 120L Waste Bags
909185	Conductive Dusting Brush
602125	130mm ATX Conductive Rubber Gulper Tool

AS10 - 908283



601008	Stainless Steel Extension Tube (x2)
601052	Stainless Steel Tube Bend with NPC Volume Control
914762	2.8m Parallel Hose
900918	300mm MultiFlo Dry Brush Tool
601430	290mm FreeFlo Floor Tool
601141	Double Taper Hose / Tool Adaptor
601145	150mm Upholstery Tool
601146	150mm Slide-on Brush for Upholstery Tool
601142	240mm Crevice Tool
601144	65mm Soft Dusting Brush
601176	Multi Size Power Tool Adaptor

AA21 - 920542



914980	1.2m RSB/RSV150 Hose
601144	65mm Soft Dusting Brush
601141	Double Taper Hose / Tool Adaptor
601142	240mm Crevice Tool
601918	560mm Stainless Steel Gulper / Scraper Tool
910945	Short Backpack TriTex Filter
908229	Roll of 10 x 120L Waste Bags

AS50



601008	Stainless Steel Extension Tube (x2)
601923	Stainless Steel Tube Bend
601321	400mm Pro Flo Brush Tool
915907	2.2m Parallel Hose
602162	152mm Rubber Brush with Stiff Bristles
602159	38 / 32mm Adaptor

AS76 - 919148



601008	Stainless Steel Extension Tube (x2)
601052	Stainless Steel Tube Bend with NPC Volume Control
900918	300mm MultiFlo Dry Brush Tool
914762	2.8m Parallel Hose
601176	Multi Size Power Tool Adaptor
601144	65mm Soft Dusting Brush
601141	Double Taper Hose / Tool Adaptor
601142	240mm Crevice Tool

BB19 - 607349 / BB20 - 607350



602102	2.4m NuFlex Threaded Hose
604017	10 x (NVM-3BH) HepaFlo Dust Bags (BB19 HZD570)
604019	10 x (NVM-4BH) HepaFlo Dust Bags (BB20 HZD900)
602161	152mm Rubber Brush with Soft Bristles
604144	65mm Soft Dusting Brush
908229	Roll of 10 x 120L Waste Bags
602160	305mm ABS Crevice Tool
602923	280mm Stainless Steel Gulper / Scraper Tool (38mm)
602159	38 / 32mm Adaptor

BB5 - 607335



602102	2.4m NuFlex Threaded Hose
602919	Stainless Steel Tube Bend
602920	Stainless Steel Extension Tube (x2)
602381	400mm ProFlo Brush Tool
602162	152mm Rubber Brush with Stiff Bristles



✓ With On-Tool Extraction

✗ Without On-Tool Extraction

TradeLine 390 on-tool extraction in use. (See page 57 for product information)

FloorCare

Providing professional cleaning results in even the most demanding environments, with innovative, reliable and effective floorcare solutions.

Contents

Hurricane / Nu-Shine / Lo-Line Range	64-65
TwinTec Mains Range	66
Nu-Assist	67
NX300 FloorCare Range	68-77
NX1K Lithium Range	78-81
Brushes & Pad Drives	82-83
FloorCare Accessories	84-85

EURO-

wszystko do
Numatic



NX 1K
Page 80 TBL4055



NEW PRODUCT
NX 300
Page 76 TTB1840NX-R

“A diverse range delivering leading cleaning results from our latest battery technologies”



NX 1K
Page 72 CRL8072



NEW PRODUCT
NX 300
Page 81 440NX

Which Machine is Best for You?



<p>Lightweight A light commercial or domestic machine. Suited to the non-professional cleaner. Perfect for a variety of flooring options, including vinyl, slate, limestone and quarry tiles.</p>	<p>Scrubbing Professional use machines for a range of deep-cleaning situations in leisure, industry and floor maintenance.</p>	<p>General Purpose Medium speed machines for a variety of uses and floor types. Lighter scrubbing and polishing on vinyl, stone and wood*.</p>
<p>Polishing Professional higher speed machines for spray cleaning and polishing a variety of floors including vinyl and wood*.</p>	<p>Burnishing Professional, ultra-high speed machines for burnishing vinyl floors treated with metallised emulsion polishes - for the wet-look shine with specialised UH speed floor pads.</p>	<p>Heavy-Duty Scrubbing Specialist scrubbing machine with extra weight for heavy-duty situations.</p>

HURRICANE/NU-SHINE



HFM1515-R
Scrubbing

HFM1523-R
General Purpose

HFM1530-R
Polishing

- Fully adjustable handle
- Optional solution tank
- Optional 10kg weight
- Optional vacuum (dry)

450MM Deck Size	1500W Motor	32KG Weight
Power 230V / AC 50Hz		
Brush Size 450mm	Pad Size 400mm	
460x560x1250mm (WxLxH)	Cleaning Range 32m	
Brush Speed RPM		
1515-R - 150, 1523-R - 230, 1530-R - 300		



HNS1550-R
Burnishing

- Fully adjustable handle
- High-speed burnisher
- Simple load adjustment
- Optional vacuum (dry)

500MM Deck Size	1500W Motor	35KG Weight
Power 230V / AC 50Hz		Cleaning Range 32m
Pad Size 500mm		Pad Pressure - Variable
560x740x1260mm (WxLxH)		Brush Speed 1500RPM



LO-LINE

NLL332-R
Lightweight
General Purpose

- Optional solution tank
- Folds flat for easy storage
- Full range of brushes and pads

330MM Deck Size	400W Motor	18KG Weight
Power 230V / AC 50Hz		Cleaning Range 32m
Solution Tank Capacity 4L		Brush Speed 200RPM
Brush Size 330mm	Pad Size 330mm	
330x540x1145mm (WxLxH)		



Easy Storage
Folds flat for compact convenience.

Wide Range of Accessories
A variety of brushes and pads are available to suit your cleaning needs.

Solution Tank (Optional)

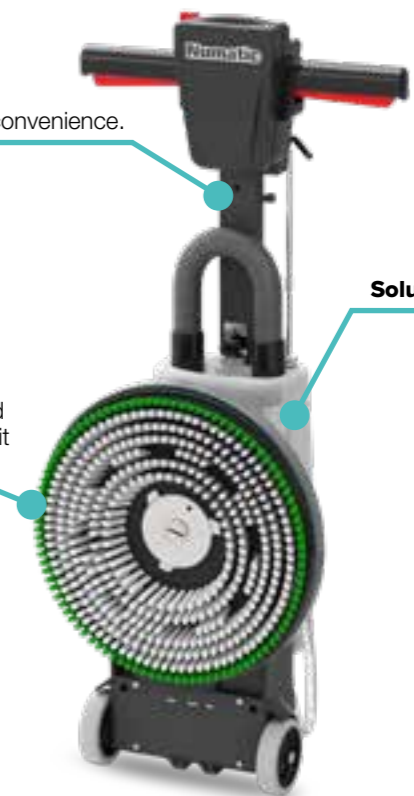

Please note information provided is for guidance only, please consult manufacturers guidance before use. *Refer to manufacturer/supplier's data sheet for advice as not all wood/laminates are waterproof.

Images may include optional accessories for illustration purposes.

TWINTec MAINS

The TwinTec 1840 Mains Cable machine has been designed to address the question of size, whilst being exceptionally compact, with a performance equal to bigger machines.

TT1840G

- Performance of a bigger machine
- Clean, dry and safe floors
- Easy brush or pad change
- User-friendly controls
- Fully adjustable handle

18L Tank Capacity	400W Brush Motor	38.5KG Net Weight
Power 230V / AC 50Hz	Cleaning Range 42m	
Deck Size 400mm	Vac Motor 300W	
Brush Size 400mm	Pad Size 360mm	
520x880x1132mm (WxLxH)		Brush Speed 150RPM



Nu-Assist Training & Support Around the Clock

The Nu-Assist App offers the benefit of online training through a simple, versatile and user-friendly solution, resulting in increased cleaning performance and productivity.

- 24/7 Access to Multilingual Training
- On-hand Troubleshooting and Maintenance
- Increased Cleaning Productivity
- Product Training

How it works

1. Scan the QR Code on Machine
2. Open in App or Mobile Browser
3. View Quick Start Videos
4. Carry Out Maintenance Checklist
5. Complete Operation Training



Scan me to download Nu-Assist App



The TwinTec Mains Cable range has masterful performance moving under its own brush power with amazing speed and purpose. Available with 450mm, 550mm or 650mm scrub width.

TT4045G / TT4055G

TT6650G



- Simple controls
- Fully adjustable handle
- Tilting deck for easy brush / pad change

- Simple controls
- Fully adjustable handle
- Tilting deck for easy brush / pad change

40L Tank Capacity	1500W Brush Motor	67/68KG Net Weight
Power 230V / AC 50Hz	Cleaning Range 42m	
Brush Speed 150RPM	Vac Motor 1200W	
TT4045G	TT4055G	
Deck Size 450mm	Deck Size 550mm	
Brush Size 450mm	Brush Size 550mm	
Pad Size 400mm	Pad Size 500mm	
470x890x1100mm (WxLxH)		560x935x1100mm (WxLxH)

60L Tank Capacity	1500W Brush Motor	87.6KG Weight
Power 230V / AC 50Hz	Cleaning Range 42m	
Deck Size 650mm	Vac Motor 1200W	
Brush Size 635mm	Pad Size 600mm	
970x1260x1230mm (WxLxH)		Brush Speed 150RPM



- 1 Fully Adjustable Handle (TT4045/4055G)
- 2 Tilting Deck for Easy Brush Change and Storage (TT4045/4055G)
- 3 Easy to Use Controls (TT4045/4055G)



GENUINE
Numatic
PART

For Genuine
Numatic
Brushes,
Pads and
Accessories
See pages 82-85



Pro Cordless Network Increases Productivity

NX300 Pro Cordless Network delivers professional level performance to a versatile and expanding range. Quicker, safer and more convenient, switching to Pro Cordless raises productivity levels, saving time and money.



More Time to Clean



Lower Maintenance



No Cable Trips



Lower Noise



Lower Energy Cost



All Hours Cleaning

Visit: numatic.com/NX300-pro-cordless

NUCLEAN COMPACT

Choose...

- Performance • Reliability • Efficiency
- Value • Safety • 3-Year Warranty
- Sustainability • NX300 Cordless Network



220NX
Small Size,
BIG Payback

440NX
Unstoppable
Performance

440NX Flex
FLEXCORE
Lighter Handling

440NX Drive
Driven
Performance



The only choice is which one?

**Small
Size**

BIG Payback

The 220NX delivers the performance of much larger scrubber dryers in an ultra-compact package. Accessing areas currently cleaned by mopping alone, bringing improved cleaning results and saving on labour costs.

- Replace Mopping
- Improved Cleaning Results
- Compact, Agile & Manoeuvrable
- NX300 Pro Cordless Network
- 3-Year Warranty



NU-ASSIST
See page 9
for more information

“Switching to a 220NX for just 30 minutes a day instead of mopping makes big savings, returning the total machine cost in under 1 year.*1”

NUCLEAN
COMPACT
220

**NEW
PRODUCT**



220NX

- 120mins runtime
- 1-hour fast charge
- One-pass performance
- Centrifugal water delivery
- Made using minimum 30% recycled plastic*, including accessories
- Part of NX300 Pro Cordless Network

1L Tank Capacity	1.5L Recovery Tank	100W Vac Motor	140RPM Brush Speed
Power 36V		Brush Motor 120W	
Recharge Time 1hr 80% / 2hrs 100%			
Deck Size 220mm		Runtime Up to 120mins	
Brush 220mm		Pad Size 220mm	
380x530x1160mm (WxLxH)		Net Weight 17kg	



2 Quick Battery Removal



4 Easy Controls & Hours Meter



3 Ultra-Compact



5 Foot-operated Floor Tool & Deck

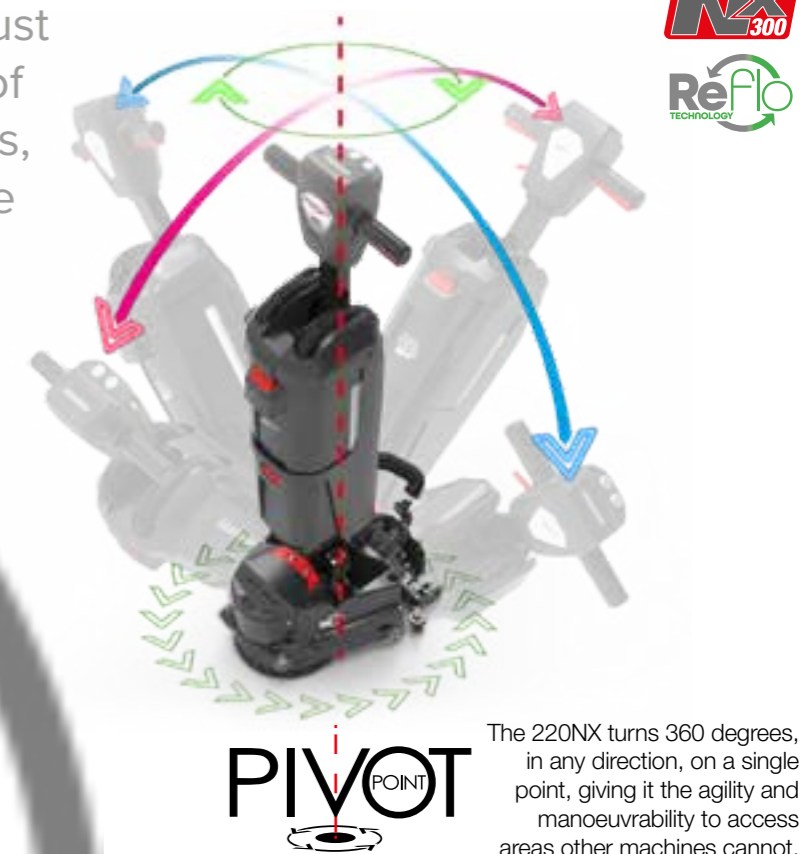

The 220NX turns 360 degrees, in any direction, on a single point, giving it the agility and manoeuvrability to access areas other machines cannot.



*1 Payback based on 300m² area clean, 7 days p/w, labour £11.44p/h VS wet mopping.
*2 Provisional figure only, subject to change.



UNSTOPPABLE PERFORMANCE

70% Labour Saving
80% Lower Water Use

- One-Pass Performance
- Agile & Lightweight
- NX300 Pro Cordless Network
- 3-Year Warranty

*Time saving of 70% vs dolly mopping / wage £11 per hour, 100sqm 7 days per week.
Water use by 80% based on replacing 16L mopping system, cleaning 7 days per week.



NUCLEAN
COMPACT
440



440NX

- 80mins runtime
- 1-hour fast charge
- One-pass performance
- Centrifugal water delivery
- Made using 20% recycled plastic, including accessories
- Part of NX300 Pro Cordless Network

2.2L Tank Capacity	3L Recovery Tank	100W Vac Motor	140RPM Brush Speed
Power 36V		Brush Motor 2x200W	
Recharge Time 1hr 80% / 2hrs 100%			
Deck Size 440mm		Runtime Up to 80mins	
Brush 2x220mm		Pad Size 2x220mm	
620x450x1180mm (WxLxH)		Net Weight 21.3kg	

Working in partnership with
 charity: water

Since 2021, we have
donated over

145 Million

Litres of Water to
Projects Around
the World.

See pages 6-7 for more information or
visit: numatic.com/charitywater

The 440NX is lightweight and easy to use, leaving floors clean, dry, safe and streak-free, whilst reducing labour costs by 70% and water use by 80%.*



Easy to Use

Simple to set up and easy to use.



Simple Fill

Removable clean tank with No-Spill Cap.



Adjustable Water Flow

Easily adjustable water flow to suit cleaning needs.



Foot-operated Brush Deck

Simple and easy to engage brush deck.



Numatic
NU-ASSIST

See page 9
for more information



DRIVEN PERFORMANCE

The Powered Drive System in the 440NX Drive enhances compact cleaning, covering larger areas and boosting productivity with a single machine.

- Lighter, Effortless Powered-Handling
- 48% Increase in Cleaning Coverage
- Reduced Operator Strain



Powered Drive System

- 1 Drive Speed Control
- 2 Easy Brush Change



NUCLEAN COMPACT 440 DRIVE



440NX DRIVE

- One-pass performance
- Powered-handling, effortless control
- Faster transit between cleaning sites
- 1-hour fast charge
- Made using 20% recycled plastic*, including accessories
- Part of NX300 Pro Cordless Network

2.2L Tank Capacity	3L Recovery Tank	100W Vac Motor	140RPM Brush Speed
Power 36V		Brush Motor 2x200W	
Recharge Time 1hr 80% / 2hrs 100%			
Traction Drive 150W		Variable Drive Speed 0-4km/h	
Deck Size 440mm		Runtime Up to 70mins	
Brush 2x220mm		Pad Size 2x220mm	
520x450x1180mm (WxLxH)		Net Weight 22.7kg	



LIGHTER EFFORTLESS HANDLING

The 440NX Flex elevates cleaning with FlexCore Technology, offering 25% lighter, effortless handling. It's perfect for navigating tight, high-traffic areas where frequent, thorough cleaning is crucial.

- Flexible Handling System
- 25% Lighter Handling
- Lower Maintenance
- Reduce Operator Strain



NUCLEAN COMPACT 440 FLEX



440NX FLEX

- 80mins runtime
- 1-hour fast charge
- 25% Lighter Handling
- Reduce Operator Strain
- Made using 20% recycled plastic*, including accessories
- Part of NX300 Pro Cordless Network

2.2L Tank Capacity	3L Recovery Tank	100W Vac Motor	140RPM Brush Speed
Power 36V		Brush Motor 2x200W	
Recharge Time 1hr 80% / 2hrs 100%			
Deck Size 440mm		Runtime Up to 80mins	
Brush 2x220mm		Pad Size 2x220mm	
520x450x1180mm (WxLxH)		Net Weight 22.5kg	

- 3 FlexCore Technology
- 4 Quick Battery Removal

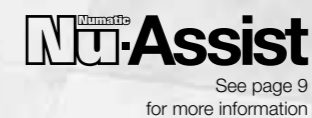

See page 9 for more information

* Provisional figure only, subject to change.

NX300



We engineer many of our products from the highest quality recycled post-industrial and post-consumer plastics using ReFlo Technology. The **TTB1840NX-R** and **TTB3045NX-R** are made using a minimum **45%** recycled plastic, including accessories.

TTB1840NX-R



- 70mins runtime
- 1-hour fast charge
- Clean, dry, safe and streak-free floors
- Centrifugal water delivery
- Made using minimum 45% recycled plastic, including accessories
- Part of the NX300 Pro Cordless Network
- Folds flat for easy storage

18L Tank Capacity	100W Vac Motor	400MM Deck Size	155RPM Brush Speed
Power 36V		Brush Motor 250W	
Recharge Time 1hr 80% / 2hrs 100%			
Brush Size 400mm		Runtime Up to 70mins	
Pad Size 360mm		Net Weight 34kg	
520x850x1132mm (WxLxH)			

TTB3045NX-R



- 70mins runtime
- 1-hour fast charge
- Compact machine, big results
- Hot-swapping between batteries
- Made using minimum 45% recycled plastic, including accessories
- Part of the NX300 Pro Cordless Network

30L Tank Capacity	210W Vac Motor	450MM Deck Size	100RPM Brush Speed
Power 2x36V		Brush Motor 300W	
Recharge Time 1hr 80% / 2hrs 100%			
Brush Size 450mm		Runtime Up to 70mins	
Pad Size 400mm		Net Weight 79.3kg	
470x915x1100mm (WxLxH)			

Sustainable Cleaning
Our Centrifugal Water System ensures precise distribution across the brush or pad, delivering on cleaning performance whilst saving water.

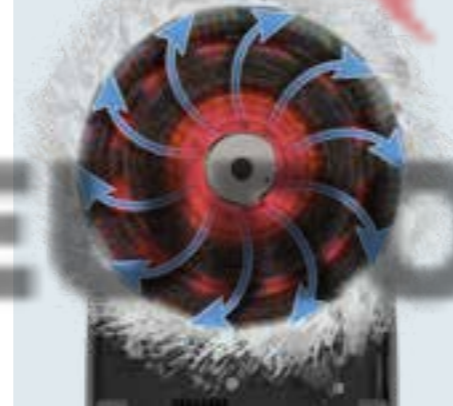

1 Easy Brush & Pad Change

2 Easy Battery Removal at the Back



3 Simple to Use Controls

4 TTB1840NX-R



5 TTB3045NX-R



Ten-Tec High-Performance Brushes

“The Ten-Tec brush raises the standard in scrub brush performance.”

All ReFlo FloorCare is equipped with Ten-Tec Brushes

- Lasts 10x longer, than a standard brush*
- Replaces up to 100 standard Numatic red pads
- 47% improved cleaning results compared to standard Numatic brushes
- Reduces the need for chemical additives, lowering cleaning costs

Available for use across the Numatic Scrubber Dryer range.
*Numatic Standard Polyscrub Brush.



Numatic
Assist
See page 9
for more information

Note: Subject to region availability, please contact your Numatic representative for information.

NX1K RANGE

Runs Longer

Configurable performance that suits you, offering increased runtime of up to 44%*. Ensuring you can keep cleaning when it is most convenient for you.

More Sustainable

NX1K lasts longer than lead alternatives, significantly reducing material use and disposal, providing a much more sustainable solution.

Fast & Flexible Charging

Unlike Lead, NX1K Fast Charge Technology allows completely flexible charging, allowing you to use your machine whenever you need to, no matter how much it's charged. NX1K Fast Charge Technology drives productivity, providing you an increase in machine availability in comparison to Lead.

Extended Long Life Power

Delivering over 4000 charge cycles, NX1K will last as long as your machine. Utilising the latest Lithium Phosphate Technology, NX1K is one of the safest battery platforms on the market. A 8-year battery warranty provides complete peace of mind for you and your cleaning fleet.†

Nu-Track Insights

Built-in with our intelligent fleet management telemetry system, Nu-Track provides in-depth insights, lowering costs and increasing productivity across your fleet.‡



“Investing in Lithium, compared to routinely replacing lead batteries and associated service costs, provides a positive return on investment across the NX1K Range, therefore saving you money.”



TBL6055

TBL8572

CRL8072



**4x Longer
Lasting
than Lead
Batteries**

* Any comparisons used are based on typical usage scenarios, results may differ. Performance comparisons use equivalent GelTec models.

† 8-Year Warranty subject to terms and market availability, please contact Numatic for more information.

‡ Nu-Track subject to market / model availability.

NX1K



NX1K battery platform powers commercial grade TwinFlo vacuum and brush motor for unrivalled cleaning performance, even in the most demanding environments.

NX1K Walk-Behind Scrubber Dryers

TBL3045



- Compact design
- Powerful cleaning results
- Flexible charging
- On-board charging

30L Tank Capacity	200W Vac Motor	100RPM Brush Speed
Brush Motor 300W	Deck Size 450mm	
Pad Size 400mm	Brush Size 450mm	
Runtime 2hr 30mins	Recharge Time 10hrs	
Net Weight 63kg	470x890x1100mm (WxLxH)	

TBL4045



- Compact design
- Powerful cleaning results
- Fast and flexible charging
- Configurable battery performance that suits you
- On-board charging

40L Tank Capacity	400W Vac Motor	140RPM Brush Speed
Brush Motor 300W	Deck Size 450mm	
Pad Size 400mm	Brush Size 450mm	
1 x Battery	2 x Battery	
Runtime 1hr 40mins	Runtime 3hrs 10mins	
Recharge Time 2hrs 30mins	Recharge Time 5hrs	
Net Weight 119.3kg	Net Weight 130.6kg	
805x1155x1160mm (WxLxH)		

TBL4055



- Compact design
- Powerful cleaning results
- Fast and flexible charging
- Configurable battery performance that suits you
- On-board charging

40L Tank Capacity	400W Vac Motor	140RPM Brush Speed
Brush Motor 300W	Deck Size 550mm	
Pad Size 508mm	Brush Size 550mm	
1 x Battery	2 x Battery	
Runtime 1hr 38mins	Runtime 3hrs 9mins	
Recharge Time 2hrs 30mins	Recharge Time 5hrs	
Net Weight 113.9kg	Net Weight 124.7kg	
948x1200x1160mm (WxLxH)		

TBL8572



- Dual brush design
- Powerful cleaning results
- Fast and flexible charging
- Configurable battery performance that suits you
- On-board charging

85L Tank Capacity	400W Vac Motor	150RPM Brush Speed
Brush Motor 600W	Deck Size 720mm	
Pad Size 2x360mm	Brush Size 2x370mm	
Traction Drive 400W	Drive Speed 0-4.2km/h	
2 x Battery	3 x Battery	
Runtime 3hrs	Runtime 4hrs 30mins	
Recharge Time 5hrs	Recharge Time 7hrs 30mins	
Net Weight 204.1kg	Net Weight 214.9kg	
762x1513x1144mm (WxLxH)		

CRL8055



- Compact design
- Powerful cleaning results
- Fast and flexible charging
- Stay cleaning for longer
- On-board charging

80L Tank Capacity	400W Vac Motor	150RPM Brush Speed
Brush Motor 600W	Deck Size 550mm	
Pad Size 508mm	Brush Size 550mm	
Traction Drive 400W	Drive Speed 0-6km/h	
1 x Battery	2 x Battery	
Runtime 1hr 20mins	Runtime 2hrs 40mins	
Recharge Time 2hrs 30mins	Recharge Time 5hrs	
Net Weight 139.8kg	Net Weight 150.6kg	
805x1460x1160mm (WxLxH)		

CRL8072



- Compact design
- Best in class scrub width
- Fast and flexible charging
- Stay cleaning for longer
- On-board charging

80L Tank Capacity	400W Vac Motor	150RPM Brush Speed
Brush Motor 600W	Deck Size 720mm	
Pad Size 2x360mm	Brush Size 2x370mm	
Traction Drive 400W	Drive Speed 0-6km/h	
1 x Battery	2 x Battery	
Runtime 1hr 20mins	Runtime 2hrs 40mins	
Recharge Time 2hrs 30mins	Recharge Time 5hrs	
Net Weight 159.8kg	Net Weight 170.6kg	
948x1450x1160mm (WxLxH)		

TBL4055T



- Compact design
- Powerful cleaning results
- Fast and flexible charging
- Configurable battery performance that suits you
- On-board charging
- Traction drive makes cleaning inclines safer and easier

40L Tank Capacity	400W Vac Motor	140RPM Brush Speed
Brush Motor 300W	Deck Size 550mm	
Pad Size 508mm	Brush Size 550mm	
Traction Drive 250W	Drive Speed 0-4km/h	
1 x Battery	2 x Battery	
Runtime 1hr 33mins	Runtime 3hrs 4mins	
Recharge Time 2hrs 30mins	Recharge Time 5hrs	
Net Weight 123.8kg	Net Weight 134.7kg	
948x1200x1160mm (WxLxH)		

TBL6055



- Big capacity, compact design
- Clean, dry, safe floors in minutes
- Fast and flexible charging
- Stay cleaning for longer with over 3 hours runtime
- On-board charging

60L Tank Capacity	400W Vac Motor	140RPM Brush Speed
Brush Motor 300W	Deck Size 550mm	
Pad Size 508mm	Brush Size 550mm	
1 x Battery	2 x Battery	
Runtime 1hr 40mins	Runtime 3hrs 10mins	
Recharge Time 2hrs 30mins	Recharge Time 5hrs	
Net Weight 115.3kg	Net Weight 126.1kg	
948x1425x1120mm (WxLxH)		

TBL6055T



- Big capacity, compact design
- Clean, dry, safe floors in minutes
- Fast and flexible charging
- Stay cleaning for longer with up to 3 hours runtime
- On-boarding charging
- Traction drive makes cleaning inclines safer and easier

60L Tank Capacity	400W Vac Motor	140RPM Brush Speed
Brush Motor 300W	Deck Size 550mm	
Pad Size 508mm	Brush Size 550mm	
Traction Drive 250W	Drive Speed 0-4km/h	
1 x Battery	2 x Battery	
Runtime 1hr 30mins	Runtime 3hrs	
Recharge Time 2hrs 30mins	Recharge Time 5hrs	
Net Weight 141.1kg	Net Weight 152kg	
948x1425x1120mm (WxLxH)		



1 CRL8072
2 TBL4045

TRL720



- User-friendly controls
- Dual brush design
- Fast and flexible charging
- Configurable battery performance that suits you
- On-board charging

120L Tank Capacity	600W Vac Motor	150RPM Brush Speed
Brush Motor 600W	Deck Size 720mm	
Pad Size 2x360mm	Brush Size 2x370mm	
Traction Drive 700W	Drive Speed 0-6.5km/h	
3 x Battery	4 x Battery	
Runtime 4hrs	Runtime 5hrs 20mins	
Recharge Time 7hrs 30mins	Recharge Time 10hrs	
Net Weight 282.6kg	Net Weight 293.4kg	
948x1676x1425mm (WxLxH)		

TVL850



- User-friendly controls
- Trio adjustable brush design
- Configurable battery performance that suits you
- On-board charging











120L Tank Capacity	600W Vac Motor	212RPM Brush Speed
Brush Motor 3 x 400W	Deck Size 650/750/850mm	
Pad Size 3x300mm	Brush Size 3x300mm	
Traction Drive 700W	Drive Speed 0-6.5km/h	
3 x Battery	4 x Battery	
Runtime 3hrs 5mins	Runtime 4hrs 10mins	
Recharge Time 7hrs 30mins	Recharge Time 10hrs	
Net Weight 287.6kg	Net Weight 298.4kg	
1054x1676x1425mm (WxLxH)		

5 x Battery & 6 x Battery configurations available for TRL720 and TVL850

Hurricane / NuSpeed

Accessories & TwinTec Blades

Using genuine Numatic accessories will ensure you achieve the best results from your FloorCare machine.

 <p>HFM Solution Tank PN: 606890</p>	 <p>NLL Solution Tank PN: 606101</p>	 <p>440NX Solution Tank PN: 913825</p>
 <p>HFM / HNS Optional SprayTec Kit PN: 606325</p>	 <p>HFM Dustrol Kit (Grey) PN: 906412</p> <p>HNS1550 Dustrol Kit (Grey) PN: 906414</p> <p>HFM Dustrol Control Brush Ring (Standard with Dustrol Kits) PN: 606079</p>	 <p>HNS / HFM Micro HEPA Filter Dustrol Kit (Grey) PN: 913060</p>
 <p>HFM 10kg Weight PN: 606077</p>		
 <p>440NX Models Replacement Blade Set (2-Pieces) PN: 913810</p>	 <p>1840 Models Replacement Blade Set (2-Pieces) PN: 903531</p>	 <p>3045 / 4045 / 4055 / 6055 / 8055 Models (805mm) PN: 900518</p> <p>3045 / 4045 / 4055 / 6055 / 8572 / 8072 / 720 Models (944mm) PN: 900519</p> <p>850 Models (1053mm) PN: 900520 Replacement Polyurethane Blade Set</p>

TwinTec

Tools & Accessories

 <p>Aluminium Floor Tool Blades Included 440NX Models PN: 913830</p>	 <p>Plastic Floor Tool Blades Included 1840 Models PN: 903532</p>	 <p>Aluminium Floor Tool Adjustable Wheels & Blades Included 3045 / 4045 / 4055 / 6055 / 8055 Models (650mm) PN: 904691 3045 / 4045 / 4055 / 6055 / 8572 / 8072 / 720 Models (750mm) PN: 904699 850 Models (850mm) PN: 904209</p>
 <p>All TT / TTB / TBL Machines Wander Floor Kit (32mm) (Except TT1840G / TTB1840NX) PN: 607250</p>	 <p>All TT / TTB / TBL Machines Wander Floor Kit (38mm), (Except TT1840G / TTB1840NX) PN: 606193</p>	 <p>440NX Transport Wheel Set PN: 919445</p>
 <p>TwinTec Emptying Hose 32mm Emptying Hose Kit PN: 609100</p>	 <p>TwinTec Castor Plate Aluminium Floor Tool Wide Angle Adjustable Castor Plate Upgrade Kit PN: 908028</p>	
 <p>Cable Roll Extension for Mains Machines 20m Cable Roll Extension UK PN: 612002</p>	<p>NX300 Battery PN: 913686</p> <p>NX300 Charging Dock PN: 911334</p> <p>NX300 Dual Charging Dock PN: 910820</p> <p>NX300 Mains Cable for Charging Docks UK PN: 912365 EURO PN: 912361 SWISS PN: 912364 AUS/NZ PN: 912360 USA PN: 912362 S.AFRICA PN: 912363 JPN PN: 913041</p>	<p>NX300 Dual Charging Dock with Mains Cable UK PN: 915748 EURO PN: 915749 SWISS PN: 915750 AUS/NZ PN: 915751 USA PN: 915752 S.AFRICA PN: 915753 JPN PN: 915754</p>
 <p>CRL Spray Mop Mounting Kit PN: 903182</p>	<p>Look out for the logo to make sure you're getting a Genuine Numatic Part.</p> 	 <p>TRL / TVL Caddy Kit PN: 902739 CRL Caddy Kit PN: 902505</p>

VersaCare

Versatility, innovation and quality are at the core of our janitorial cleaning systems. Attention to detail and practical engineering ensure complete customer satisfaction in function, operation and convenience.

Contents

Mop Kits	88-89
MULTI-Matic Range	90-93
ECO-Matic Range	94-97
SERVO-Matic Range	98-101
PRO-Matic Range	102-106
SRK Kits	107
Carousel Range	109
NuBag Range	110
Servo-X Range	111
NuKeeper Range	112-117
NuKeeper Top Tray & Hood Kits	118
NuKeeper End Frame Kits	119



Page 89 MMB1616



Page 116 NKU31RHF

“Raising cleaning standards and productivity with versatility, innovation and quality..”



Page 111 NX1002



Page 90-93 MM4



MOP KITS



<p>PCM403 POLYSTATIC 3-PIECE MOP SET</p>  <ul style="list-style-type: none"> □ C/W 50 x PolyStatic Mop Cloths □ Disposable PolyStatic Mop "Gripper" Pad □ Velcro Fixing □ Pad Size 400mm PN: 629813 	<p>PCT400 POLYSTATIC TELESCOPIC MOP SET</p>  <ul style="list-style-type: none"> □ C/W 50 x PolyStatic Mop Cloths □ Disposable PolyStatic Mop "Gripper" Pad □ Velcro Fixing □ Pad Size 400mm PN: 913816 	<p>PSM400G POLYSTATIC SPRAYMOP SET</p>  <ul style="list-style-type: none"> □ C/W 50 x PolyStatic Mop Cloths □ C/W Disposable PolyStatic Mop "Gripper" Pad □ C/W 400ml Bottle □ Velcro Fixing □ Pad Size 400mm PN: 906193
<p>POLYSTATIC GRIPPER PAD</p>  <ul style="list-style-type: none"> □ Disposable PolyStatic Mop "Gripper" Pad PN: 629810 	<p>DTK1 KENTUCKY MOP SET</p>  <ul style="list-style-type: none"> □ C/W 1 x Kentucky 400g Mop □ Suitable for Vertical Press PN: 629332 	<p>DTK2 POCKET MOP SET</p>  <ul style="list-style-type: none"> □ C/W 1 x BluTec Microfibre Pocket Mop □ Suitable for Vertical Press, Wide Press and MopMatic □ Pocket Fixing □ Pad Size 400mm PN: 629333
<p>POLYSTATIC MOP DUSTERS</p>  <ul style="list-style-type: none"> □ Fits on PCM403, PSM400G □ Pack of 50 x PolyStatic Mop Cloths White PN: 629811 Red PN: 902192 Blue PN: 902193 Green PN: 902194 Yellow PN: 902195 □ Carton of 400 x PolyStatic Mop Cloths, (8 x 50) White PN: 629812 □ Carton of 400 x PolyStatic Mop Cloths, (8 x 50) PN: 629844 C/W 2 x "Gripper" Pads 	<p>DTK4 VELCRO MOP SET</p>  <ul style="list-style-type: none"> □ C/W 1 x BluTec Microfibre Mop □ Suitable for Wide Press and MopMatic □ Velcro Fixing □ Pad Size 400mm PN: 629335 	<p>DTK6G SPRAYMOP MASTER SET</p>  <ul style="list-style-type: none"> □ C/W 1 x BluTec Microfibre Pocket Mop □ C/W 400ml Bottle □ Pocket Fixing □ Pad Size 400mm PN: 906194
<p>DTK3 HANG-ON MOP SET</p>  <ul style="list-style-type: none"> □ C/W 1 x BluTec Microfibre Mop □ Suitable for Vertical Press □ Hang-on Fixing □ Pad Size 400mm PN: 629334 	<p>DTK9 TWIST MOP</p>  <ul style="list-style-type: none"> □ C/W 1 x Bactiguard Mop PN: 906460 	<p>DTK10 MULTIMOP</p>  <ul style="list-style-type: none"> □ C/W 1 x Sponge □ Folding Press □ Velcro Fixing □ Sponge Size 350mm PN: 628119
<p>DTK8G SPRAYMOP MASTER SET</p>  <ul style="list-style-type: none"> □ C/W 1 x BluTec Microfibre Velcro Mop □ C/W 400ml Bottle □ Velcro Fixing □ Pad Size 400mm PN: 906195 	<p>DTK13G WING MOP PUMP ACTION SET</p>  <ul style="list-style-type: none"> □ C/W 1 x BluTec Microfibre Hang-on Mop □ Suitable for Vertical Press □ Hang-on Fixing □ Pad Size 400mm PN: 909278 	<p>COLOUR-CODED MOP STICK/PRESS CLIPS</p>  <p>Pack of 10 PN:</p> <ul style="list-style-type: none"> □ Red: 915499 □ Blue: 915500 □ Green: 915501 □ Yellow: 915502
<p>DTK12G WING MOP PUMP ACTION SET</p>  <ul style="list-style-type: none"> □ C/W 1 x BluTec Microfibre Pocket Mop □ Suitable for Vertical Press, Wide Press and MopMatic □ Pocket Fixing □ Pad Size 400mm PN: 906205 		

The MidMop is always on-hand and easily stored, with a compact design providing a go-anywhere twin-bucket mopping system.



MMB1616 shown with Optional Mop Stand and DTK13G Mop Set Consumables for illustration purposes only.

MM30G



HB1812R



MMB1616



- C/W 1 x Sponge
- Velcro Fixing
- 30L Capacity Bucket
- Folding Press
- Castors: 4 x 50mm
- Sponge Size 350mm
- 340x475x320mm (WxLxH)

- Vertical Press for Flat or Kentucky/Twist Mop
- 18L Clean Capacity / 12L Dirty Capacity
- Optional Mop Kits: DTK1 / DTK2 / DTK3 / DTK12G / DTK13G
- Castors: 4 x 75mm
- 410x560x800mm (WxLxH)

- Vertical Press for Flat or Kentucky/Twist Mop
- 16L Clean Capacity / 16L Dirty Capacity
- Optional Mop Kits: DTK1 / DTK2 / DTK3 / DTK12G / DTK13G
- Optional Handle
- Castors: 4 x 75mm
- 510x680x1020mm (WxLxH)

MULTI-MATIC

Designed for enhanced usability, productivity and simplicity, MULTI-Matic offers a choice of 9 models to suit any cleaning task or environment.

Numatic Design
Bespoke Janitorial
See page 9



Made using Recycled Plastic

ReFlo Technology uses the highest quality recycled plastic, delivering the same Numatic reliability, durability and quality as always.

Compact & Versatile Mopping Trolley

MM0



MM1



MM2



MM3



MM4



MM5



MM6



MM7









MM8



MODEL	MM0	MM1	MM2	MM3	MM4	MM5	MM6	MM7	MM8
Waste Bag Capacity	-	-	70L	-	70L	-	70L	-	70L
Storage	-	-	-	-	-	Shelf	Shelf	-	-
Castors	4 x 75mm	4 x 75mm	4 x 75mm	4 x 75mm	4 x 75mm	4 x 75mm	4 x 75mm	4 x 75mm	4 x 75mm
Press	-	-	-	Vertical Press	Vertical Press	-	-	-	-
Swing Buckets	-	2 x 5L	2 x 5L	2 x 5L	2 x 5L	2 x 5L	2 x 5L	2 x 5L	2 x 5L
Mop Bucket	-	1 x 28L	1 x 28L	1 x 15 / 1 x 17L	1 x 15 / 1 x 17L	-	-	1 x Dosed, 1 x 28L	1 x Dosed, 1 x 28L
Hooks	-	1 x Large T-Slot Hook	1 x Large T-Slot Hook	1 x Large T-Slot Hook	1 x Large T-Slot Hook	1 x Large T-Slot Hook	1 x Large T-Slot Hook	1 x Large T-Slot Hook	1 x Large T-Slot Hook
Clips	-	1 x T-Slot Mopstick Clip	1 x T-Slot Mopstick Clip	1 x T-Slot Mopstick Clip	1 x T-Slot Mopstick Clip	1 x T-Slot Mopstick Clip	1 x T-Slot Mopstick Clip	1 x T-Slot Mopstick Clip	1 x T-Slot Mopstick Clip
Dimensions (WxLxH)	480x940x1130 mm	480x940x1130 mm	480x940x1130 mm	480x940x1130 mm	480x940x1130 mm	480x940x1130 mm	480x940x1130 mm	480x940x1130 mm	480x940x1130 mm

MULTI-Matic Mop Kits & Accessories

5L SWING BUCKET  <ul style="list-style-type: none"> 5L Swing Bucket, Red Handle PN: 905225 5L Swing Bucket, Blue Handle PN: 905226 5L Swing Bucket, Green Handle PN: 905227 5L Swing Bucket, Yellow Handle PN: 905228 	5L SWING BUCKET LID  <ul style="list-style-type: none"> Lid for 5L Swing Bucket, Clear PN: 902108 	5L SWING BUCKET KIT  <ul style="list-style-type: none"> 5L Bucket Holder C/W Fixing, Black PN: 629050 5L Swing Bucket Kit, Red Handle PN: 906277 5L Swing Bucket Kit, Blue Handle PN: 906278 5L Swing Bucket Kit, Green Handle PN: 906279 5L Swing Bucket Kit, Yellow Handle PN: 906280 	15L TWINMOP BUCKET  <ul style="list-style-type: none"> 15L TwinMop Bucket, Red Handle PN: 905221 15L TwinMop Bucket, Blue Handle PN: 905222 15L TwinMop Bucket, Green Handle PN: 905223 15L TwinMop Bucket, Yellow Handle PN: 905224 	
17L FRONT MOP BUCKET  <ul style="list-style-type: none"> 1 x 17L Bucket, Blue Handle Used on: MM3 / 4 PN: 915058 	15L REAR MOP BUCKET  <ul style="list-style-type: none"> 1 x 15L Bucket, Red Handle Used on: MM3 / 4 PN: 915057 	28L TWINMOP BUCKET  <ul style="list-style-type: none"> 28L TwinMop Bucket, Red Handle PN: 905217 28L TwinMop Bucket, Blue Handle PN: 905218 28L TwinMop Bucket, Green Handle PN: 905219 28L TwinMop Bucket, Yellow Handle PN: 905220 Used on: MM1 / 2 / 7 / 8 	MOP BASKET  <ul style="list-style-type: none"> Dolly Mop Basket PN: 906729 	WASTE BAG SECURING MOULDING  <ul style="list-style-type: none"> Used on: MM2 / 4 / 6 / 8 PN: 913978
WASTE BIN LID  <ul style="list-style-type: none"> Used on: MM2 / 4 / 6 / 8 PN: 913979 	TOP STORAGE TRAY  <ul style="list-style-type: none"> Used on: MM1 / 3 / 5 / 7 PN: 913981 	MID STORAGE TRAY  <ul style="list-style-type: none"> Used on: MM5 / 6 PN: 915060 	MOP DOSING LID  <ul style="list-style-type: none"> Dosed Mop Bucket Lid Used on: MM7 / 8 PN: 915406 	MOP DOSING BUCKET  <ul style="list-style-type: none"> Dosed Mop Bucket, Blue Handle Used on: MM7 / 8 PN: 915407
MOUNTING BRACKET  <ul style="list-style-type: none"> Dosed Mop Bucket Bracket Frame Used on: MM7 / 8 PN: 915613 	VERTICAL MOP PRESS  <ul style="list-style-type: none"> Flat Mop Press Used on: MM3 / 4 PN: 915326 Kentucky/Twist Mop Press Used on: MM3 / 4 PN: 915237 	WHEEL KIT  <ul style="list-style-type: none"> Large Wheel Kit PN: 915320 	FABRIC WASTE BAG  <ul style="list-style-type: none"> Multi-pocket for Convenient Storage PN: 915319 	BAG SPLITTER KIT  <ul style="list-style-type: none"> 1 x Bag Splitter Kit C/W 70L Waste Bags Used on: MM 2 / 4 / 6 / 8 PN: 919813
GREY CADDY  <ul style="list-style-type: none"> Carry Cleaning Products PN: 628437 	TWIN 1L BOTTLE HOLDER  <ul style="list-style-type: none"> Twin 1L Bottle Holder, ReFlo Black PN: 910375 	MOP SUPPORT KIT  <ul style="list-style-type: none"> 1 x Mop Support for on-board Mop Storage PN: 915321 	LARGE & SMALL T-SLOT HOOK  <ul style="list-style-type: none"> A - Large T-Slot Hook (x1) PN: 911936 A - Large T-Slot Hook (x10) PN: 912547 B - Small T-Slot Hook (x1) PN: 915171 B - Small T-Slot Hook (x10) PN: 915325 	MOP CLAMP & CLIP  <ul style="list-style-type: none"> C - T-Slot Clamp (x1) PN: 912528 C - T-Slot Clamp (x10) PN: 912529 D - Mopstick Clip (x1) PN: 629874 D - Mopstick Clip (x10) PN: 629883

WET FLOOR SIGN  <ul style="list-style-type: none"> Wet Floor Sign with Tray-Fix Hooks, Yellow A - PN: 629044 Wet Floor Sign, Yellow, English B - PN: 901457 	PCM403 POLYSTATIC 3-PIECE MOP SET  <ul style="list-style-type: none"> 50 x PolyStatic Mop Cloths Disposable PolyStatic Mop "Gripper" Pad Velcro Fixing Pad Size 400mm PN: 629813 	DTK1 KENTUCKY MOP SET  <ul style="list-style-type: none"> 1 x Kentucky 400g Mop Suitable for Vertical Press PN: 629332 	DTK2 POCKET MOP SET  <ul style="list-style-type: none"> 1 x BluTec Microfibre Pocket Mop Suitable for Vertical Press, Wide Press and MopMatic Pocket Fixing Pad Size 400mm PN: 629333
DTK3 HANG-ON MOP SET  <ul style="list-style-type: none"> 1 x BluTec Microfibre Mop Suitable for Vertical Press Hang-on Fixing Pad Size 400mm PN: 629334 	DTK9 TWIST MOP  <ul style="list-style-type: none"> 1 x Bactiguard Mop PN: 906460 	DTK12G WING MOP PUMP ACTION SET  <ul style="list-style-type: none"> 1 x BluTec Microfibre Pocket Mop Suitable for Vertical Press, Wide Press and MopMatic Pocket Fixing Pad Size 400mm PN: 906205 	DTK13G WING MOP PUMP ACTION SET  <ul style="list-style-type: none"> 1 x BluTec Microfibre Hang-on Mop Suitable for Vertical Press Hang-on Fixing Pad Size 400mm PN: 909278

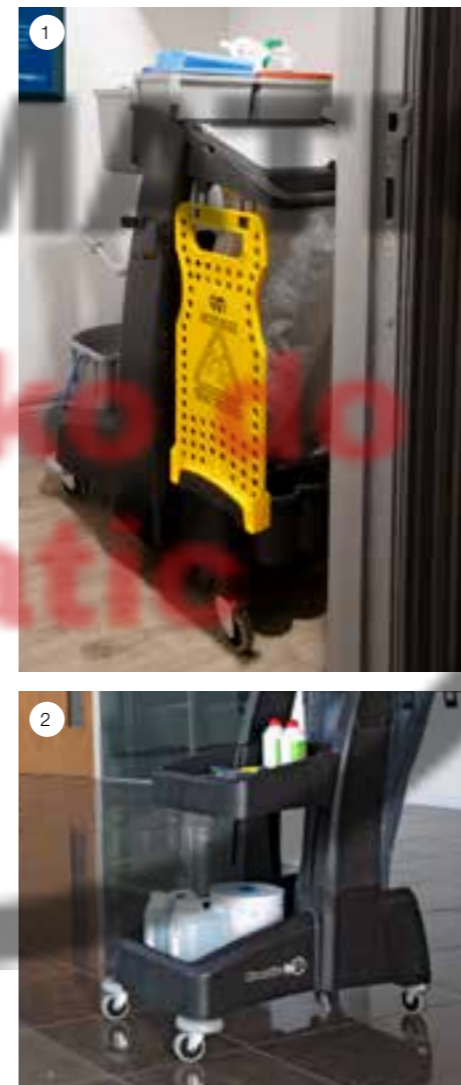

1 Compact, convenient and easy to store when not in use
 2 & 3 Open shelf storage for easy access to all your cleaning equipment and supplies on the move

A compact and versatile trolley range, ensuring productivity with a choice of janitorial solutions and mopping options to suit all environments.



ECO-MATIC

Made using the highest quality recycled plastic, each model in the ECO-Matic range benefits from 100% Structofoam construction, making it tough, easy to clean and built to last.

The best value cleaning trolley range on the market.

- Ergonomically Designed
- Enhanced Sustainability
- Built to Last



Our ReFlo produced Janitorial Range of products carry the globally recognised SCS Recycled Content Certification.

Working with an independent auditing body provides complete transparency and assurance to our customers. All our products certified by SCS Global Services guarantee a minimum amount of recycled material is used.

Mopping Storage & Waste

EM1



EM2



EM3



EM4



EM5



EM6



EM1 with Kit SRK14 and SRK21. Consumables for illustration purposes only.



EM6 with Kit SRK22 and Optional Wet Floor Sign. Consumables for illustration purposes only.

EM3 with Kit SRK16 / SRK16K and Optional Wet Floor Sign. Consumables for illustration purposes only.

MODEL	EM1	EM2	EM3	EM4	EM5	EM6
Waste Bag Capacity	120 / 2 x 70L	120 / 2 x 70L	120 / 2 x 70L	2 x 120 / 4 x 70L	120 / 2 x 70L	2 x 120 / 4 x 70L
Storage	Shelf	2 x Deep Drawers	Shelf	Shelf	2 x Deep Drawers	2 x Deep Drawers
Castors	4 x 100mm	4 x 100mm	4 x 100mm	4 x 100mm	4 x 100mm	4 x 100mm
Kits	SRK14 / 20 / 21 / 22	SRK14 / 20 / 21 / 22	SRK15 / 16 / 19 / 20 / 21 / 22	SRK 20 / 21 / 22	SRK15 / 16 / 19 / 20 / 21 / 22	SRK20 / 21 / 22
Optional Security	-	Lockable Drawers	-	-	Lockable Drawers	Lockable Drawers
Optional SprayMop	Yes	Yes	-	-	-	-
Wall and Door Buffers	Yes	Yes	Yes	Yes	Yes	Yes
Dimensions (WxLxH)	545x900x1000mm	545x900x1000mm	545x1160x1000mm	545x1230x1000mm	545x1160x1000mm	545x1230x1000mm

ECO-MATIC

All-In-One, Ready To Go Compact Solution

- Compact Design
- Convenient Storage
- Enhanced Sustainability



ECO-Matic Mop Kits & Accessories



EM2-TM with Kits SRK14, SRK22 and DTK9 Twist Mop. Consumables for illustration purposes only.



EM1-TM with Kits SRK14, SRK22 and DTK9 Twist Mop. Consumables for illustration purposes only.

<p>KIT SRK14</p> <ul style="list-style-type: none"> 1 x 18L Blue Handle Bucket, Grey C/W Mop Basket Used on: EM1 / EM2 PN: 910439 	<p>KIT SRK15</p> <ul style="list-style-type: none"> 1 x 34L Blue Handle Bucket, Grey C/W Mop Basket Used on: EM3 / EM5 PN: 910440 	<p>KIT SRK16 / SRK16K</p> <ul style="list-style-type: none"> Vertical Press for Flat or Kentucky/Twist Mop 1 x 17L Red Handle Bucket, Grey 1 x 17L Blue Handle Bucket, Grey Used on: EM3 / EM5 Flat Mop Press PN: 910442 Kentucky Mop Press PN: 910443 	<p>KIT SRK19 BAG FRAME KIT</p> <ul style="list-style-type: none"> 1 x ReFlo Bag Frame with Fixing Screws 1 x ReFlo Bag Securing Frame 1 x Grey Lid C/W Colour-coded Discs Used on: EM3 / EM5 PN: 910843 	<p>KIT SRK20</p> <ul style="list-style-type: none"> Rear Wheel Assembly Used on: EM Range PN: 910758
<p>KIT SRK21</p> <ul style="list-style-type: none"> 4 x 5L Swing Pails 5L Swing Pail Handle, Red / Blue / Green / Yellow Used on: EM Range PN: 910898 	<p>KIT SRK22</p> <ul style="list-style-type: none"> 2 x 10L Buckets, Grey 10L Bucket Handle, Red / Blue Used on: EM Range PN: 911401 	<p>MOP CLIPS</p> <ul style="list-style-type: none"> Mopstick Clip (x1) ReFlo Black PN: 629874 Mopstick Clip (x10) ReFlo Black PN: 629883 Used on: EM Range 	<p>LARGE T-SLOT HOOK, SMALL T-SLOT HOOK</p> <ul style="list-style-type: none"> Large (x1) A - PN: 911936 Large (x10) A - PN: 912547 Small (x1) B - PN: 915171 Small (x10) B - PN: 915325 	<p>ECO-MATIC BAG SPLITTER KIT</p> <ul style="list-style-type: none"> 1 x Bag Splitter with Fixing Screws for Dual Waste 1 x Bag Trapper Extrusion C/W Bags C/W Roll of 70L Waste Bags C/W Colour-coded Discs Used on: EM Range PN: 910840
<p>MOP SUPPORT KIT</p> <ul style="list-style-type: none"> 1 x Mop Support for On-board Mop Storage Used on: EM Range PN: 915321 	<p>ZIPPED LAUNDRY BAG</p> <ul style="list-style-type: none"> 1 x Zipped Laundry Bag Used on: EM Range PN: 909369 	<p>WET FLOOR SIGN</p> <ul style="list-style-type: none"> Wet Floor Sign Assembly, Yellow, English Used on: EM Range PN: 901457 	<p>DTK9 TWIST MOP</p> <ul style="list-style-type: none"> C/W 1 x Bactiguard Mop Used on: EM Range PN: 906460 	<p>NUMATIC QUICK TROLLEY BRACKET</p> <ul style="list-style-type: none"> 1 x Numatic Quick Trolley Bracket Used on: EM Range PN: 916341

Numatic
Bespoke Janitorial
See page 9

MODEL	EM1-TM	EM2-TM
Waste Bag Capacity	120 / 2 x 70L	120 / 2 x 70L
Storage	Shelf	2 x Deep Drawers
Castors	4 x 100mm	4 x 100mm
Kits	SRK14 / 22 / DTK9	SRK14 / 22 / DTK9
Optional Security	-	Lockable Drawers
Wall and Door Buffers	Yes	Yes
Dimensions (WxLxH)	545x900x1000mm	545x900x1000mm

EM1-TM



EM2-TM



- Robust design to protect the Numatic Quick
- Easy to fit
- Compact in size
- Integrated non-marking buffers for wall and door protection



SERVO-MATIC

SERVO-Matic offers an SM0 base unit with the opportunity to add extra fixtures and fittings to create the perfect fit for your janitorial needs.

Selecting the perfect fit is easy with SERVO-Matic.

- Increase Productivity
- Exceptionally Tough
- Enhanced Sustainability



Compact Storage & Waste Trolley

Obtain maximum cleaning efficiency for each environment, cleaning schedule and operator.

Selecting the perfect fit is easy with SERVO-Matic.



Removable Bin Feature
Completely detachable and manoeuvrable swing-out bin for convenient waste removal. Colour-coding options available for effective infection control. (SM3)

- 1 Non-Marking Buffers for Wall & Door Protection
- 2 Integrated Wet Floor Sign Storage
- 3 Open Shelf Storage for Easy Access of Equipment



MODEL	SM0	SM1	SM2	SM3	SM4	SM5
Waste Bag Capacity	-	120L / 2 x 70L	120L / 2 x 70L	120L / 2 x 70L	120L / 2 x 70L	120L / 2 x 70L
Storage	Storage Drawer	Storage Drawer	Storage Drawer	Storage Drawer	Storage Drawer	Storage Drawer
Castors	4 x 125mm (2 x Braked, 2 x Standard)	4 x 125mm (2 x Braked, 2 x Standard)	4 x 125mm (2 x Braked, 2 x Standard)	4 x 125mm (2 x Braked, 2 x Standard)	4 x 125mm (2 x Braked, 2 x Standard)	4 x 125mm (2 x Braked, 2 x Standard)
Bin Surround	-	-	Yes	Yes	-	-
Dimensions (WxLxH)	580x968x1083mm	570x1325x1115mm	570x1325x1115mm	580x1335x1073mm	580x1720x1130mm	570x1120x1115mm



Made using Recycled Plastic

ReFlo Technology uses the highest quality recycled plastic, delivering the same Numatic reliability, durability and quality as always.

Nu-Design
Bespoke Janitorial
See page 9



- Select your Trolley Base
- Pick your Storage Options
- Choose your Accessories
- Submit your Configuration

Visit: numaticsupport.com/nu-design

SERVO-Matic SM5

The SM5 comes complete with a more cost-effective and accessible solution to storing your 440NX scrubber dryer.



SM5 with 440NX Bracket



1. Mount to pivot point
2. Lift and click into position
3. Retract clip to release





Please note: Ensure brakes are applied on castors before attaching.



SERVO-Matic End Kit Options

 <p>SM1 120L WASTE BIN END KIT</p> <ul style="list-style-type: none"> 120L Bag Tray Bag Frame & Lid Set 120L Waste Bags (Roll of 10) PN: 919709 	 <p>SM2 WASTE BIN COVER KIT</p> <ul style="list-style-type: none"> Waste Bag Surround Support Frame Bin Lid Push Handles PN: 919418 	 <p>SM3 SWING OUT BIN END KIT</p> <ul style="list-style-type: none"> Kit SRK49 (Swing-out bin) Trolley Extension Tray 4 x Castors Push Handles PN: 919420 	 <p>SM4 240L WASTE SYSTEM KIT</p> <ul style="list-style-type: none"> 240L Bag Frame & Lid Set Trolley Extension Tray 120L Waste Bags (Roll of 10) 2 x Castors Push Handles PN: 917138
 <p>SM5 440NX BRACKET KIT</p> <ul style="list-style-type: none"> Bag Frame & Lid Set 440NX Bracket Kit 120L Waste Bags (Roll of 10) PN: 919423 	 <p>SM0 PUSH HANDLE</p> <ul style="list-style-type: none"> 919683 Push Handle for SM0 Trolley PN: 906341 	 <p>SM TROLLEY SYSTEM KIT</p> <ul style="list-style-type: none"> 16L Shallow Storage Box 35L Deep Storage Box C/W Divider Kit SRK30 120L Zipped Waste Bag Coverall Used on: SM1 / 4 / 5 PN: 919297 	

SERVO-Matic Mop Kits & Accessories

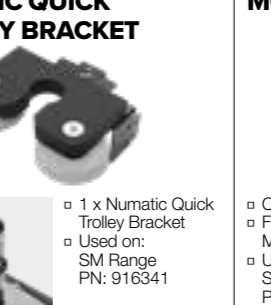
<p>KIT SRK0 / SRK0K</p>  <ul style="list-style-type: none"> Vertical Press for Flat or Kentucky/Twist Mop 1 x 15L Red Handle Bucket, Grey 1 x 15L Blue Handle Bucket, Grey Used on: SM0 / 1 / 2 / 3 / 4 Flat Mop Press PN: 910413 Kentucky/Twist Mop Press PN: 910414 	<p>KIT SRK1 / SRK1K</p>  <ul style="list-style-type: none"> Vertical Press for Flat or Kentucky/Twist Mop 1 x 17L Red Handle Bucket, Grey 1 x 17L Blue Handle Bucket, Grey 1 x Bucket Support Tray Used on: SM0 / 1 / 2 / 3 / 4 Flat Mop Press PN: 910415 Kentucky/Twist Mop Press PN: 910416 	<p>KIT SRK2 / SRK2K</p>  <ul style="list-style-type: none"> Vertical Press for Flat or Kentucky/Twist Mop 1 x 22L Red Handle Bucket, Grey 1 x 22L Blue Handle Bucket, Grey 1 x Extension Tray Used on: SM0 / 1 / 2 / 3 / 4 Flat Mop Press PN: 910425 Kentucky/Twist Mop Press PN: 910426 	<p>KIT SRK3</p>  <ul style="list-style-type: none"> Speedclean Wide Press 1 x 22L Red Handle Bucket, Grey 1 x 22L Blue Handle Bucket, Grey 1 x Extension Tray Used on: SM0 / 1 / 2 / 3 / 4 PN: 910430
<p>KIT SRK4</p>  <ul style="list-style-type: none"> 1 x MopMatic2 Bucket, Grey C/W Set of Colour-coded Discs 1 x 22L Red Handle Bucket, Grey 1 x Extension Tray C/W 2.5L Dosing Bottle Used on: SM0 / 1 / 2 / 3 / 4 PN: 910433 	<p>KIT SRK5</p>  <ul style="list-style-type: none"> 2 x MopMatic2 Bucket, Grey C/W Set of Colour-coded Discs 1 x 22L Red Handle Bucket, Grey, C/W Lid MopMatic2 Hang-on Frame, Nutex 1 x Extension Tray C/W 2.5L Dosing Bottle Used on: SM0 / 1 / 2 / 3 / 4 PN: 910435 	<p>KIT SRK6</p>  <ul style="list-style-type: none"> 2 x MopMatic2 Bucket, Grey C/W Set of Colour-coded Discs 1 x 22L Red Handle Bucket, Grey, C/W Lid MopMatic2 Hang-on Frame, Nutex 1 x Extension Tray C/W 2.5L Dosing Bottle Used on: SM0 / 1 / 2 / 3 / 4 PN: 910436 	<p>KIT SRK62</p>  <ul style="list-style-type: none"> Hood Set Lockable Used on: SM Range PN: 910315
<p>MIDMOP OPTION MMB1616</p>  <ul style="list-style-type: none"> Vertical Press for Flat or Kentucky/Twist Mop 510x680x1020mm (WxLxH) Used on: SM0 / 1 / 2 / 3 / 4 	<p>KIT SRK30</p>  <ul style="list-style-type: none"> Optional Single Door and Back C/W Locks and Hinges Used on: SM Range 	<p>WET FLOOR SIGN</p>  <ul style="list-style-type: none"> Wet Floor Sign, Yellow, English Used on: SM Range PN: 901457 	<p>KIT SRK21</p>  <ul style="list-style-type: none"> 4 x 5L Swing Pails 5L Pail Handle, Red / Blue / Green / Yellow Used on: SM Range PN: 910898 <p>KIT SRK22</p>  <ul style="list-style-type: none"> 2 x 10L Buckets 10L Bucket Handle, Red / Blue Used on: SM Range PN: 911401
<p>16L SHALLOW STORAGE BOX</p>  <ul style="list-style-type: none"> 2 x 10L Buckets 10L Bucket Handle, Red / Blue Used on: SM Range PN: 910305 	<p>35L DEEP STORAGE BOX</p>  <ul style="list-style-type: none"> Deep Storage Box, 35L, without Lids, ReFlo Black, C/W Divider Used on: SM Range PN: 910301 	<p>NUMATIC QUICK TROLLEY BRACKET</p>  <ul style="list-style-type: none"> 1 x Numatic Quick Trolley Bracket Used on: SM Range PN: 916341 	<p>MOUNTING BRACKET</p>  <ul style="list-style-type: none"> Optional Attachment For use with Mop Dosing Bucket Used on: SM Range PN: 916646

PRO-MATIC

The PRO-Matic range offers a 100% configurable cleaning system, increasing operator usability and productivity.

Unlimited configuration options with complete versatility.

- Fully Customisable
- Safe & Secure
- Enhanced Sustainability



Nu-Design
Bespoke Janitorial
See page 9

Configurable, Safe & Secure



A choice of 12 base units and a wide-range of kits and accessories, no detail goes unmissed with PRO-Matic; meeting the precise requirements of any user, in any environment, for any application.

Removable Bin Feature



Removable Bin Feature
Completely detachable and manoeuvrable swing-out bin for convenient waste removal. Colour-coding options available for effective infection control.



1 Safe & Secure Storage
2 Drawer Storage Options

MODEL	PM10	PM11	PM12	PM20	PM21	PM22	PM30	PM31	PM32
Waste Bag Capacity	1 x 120L / 2 x 70L	1 x 120L / 2 x 70L	2 x 120L / 4 x 70L	1 x 120L / 2 x 70L	1 x 120L / 2 x 70L	2 x 120L / 4 x 70L	1 x 120L / 2 x 70L	1 x 120L / 2 x 70L	2 x 120L / 4 x 70L
Storage Drawers	-	Optional	-	Optional	Optional	Optional	Optional	Optional	Optional
Doors	-	Optional	-	Optional	Optional	Optional	Optional	Optional	Optional
Castors Size	Optional	Optional	Optional	Optional	Optional	Optional	Optional	Optional	Optional
Dimensions (WxLxH)	580x972x1073 mm	580x972x1073 mm	580x972x1073 mm	580x1335x1073 mm	580x1335x1073 mm	580x1335x1073 mm	580x1700x1073 mm	580x1700x1073 mm	580x1700x1073 mm



Our ReFlo produced Janitorial Range of products carry the globally recognised SCS Recycled Content Certification.

Working with an independent auditing body provides complete transparency and assurance to our customers. All our products certified by SCS Global Services guarantee a minimum amount of recycled material is used.

Nu-Design

Nu-Design guides you through the product configuration process, providing a visual output and configuration breakdown at each selection.

See page 9



Visit: numaticsupport.com/nu-design

Configurable Cleaning Systems

The PRO-Matic PM24 and PM34 provide a lockable multi-waste recycling system, offering the options to separate your waste responsibly with a choice of 3 or 4 industry colour-coded bins.



PM24 with SRK21 and SRK22 Kits and SRK28 Door Panel Kits. Consumables for illustration purposes only.

PRO-Matic Trolley Range

The PM13 provides a lockable and manoeuvrable solution.

A completely configurable cleaning system with a wide choice of features to suit operator usability and productivity. Ready for anything, always on the go and on-hand wherever you need it.

PM13



- Optional Castors
- Optional Doors
- Optional Storage Drawers
- 580x972x1073mm (WxLxH)

PM13 OPTIONAL CONFIGURATIONS



- 2 x Deep Storage Drawers
- 4 x Shallow Storage Drawers
- 6 x Storage Box Runners
- Castors: 4 x 100mm
- Lockable Doors
- 4 x 5L Pails
- 2 x 10L Buckets
- 580x972x1073mm (WxLxH)



- 2 x Deep Storage Drawers
- 4 x Shallow Storage Drawers
- 6 x Storage Box Runners
- Castors: 4 x 100mm
- 580x972x1073mm (WxLxH)



- 2 x Deep Storage Drawers
- 4 x Shallow Storage Drawers
- 6 x Storage Box Runners
- Castors: 4 x 100mm
- Lockable Doors
- 580x972x1073mm (WxLxH)



PM13 with SRK21 and SRK22 Kits, 2 x Deep Storage Drawers and 4 x Shallow Storage Drawers and Lockable Doors. Consumables for illustration purposes only.



PM34 with SRK21 and SRK22 Kits and SRK29 Door Panel Kits. Consumables for illustration purposes only.

PM24



- Waste Bag Capacity 3 x 120L / 6 x 70L
- End Detachable Wheeled Bins and Central Static Bin
- Castors 6 x 125mm
- 2 x Lockable Doors
- Industry Colour-coding
- 580x1335x1073mm (WxLxH)

PM34



- Waste Bag Capacity 4 x 120L / 8 x 70L
- End Detachable Wheeled Bins and Central Static Bins
- Castors 8 x 125mm
- 4 x Lockable Doors
- Industry Colour-coding
- 580x1700x1073mm (WxLxH)

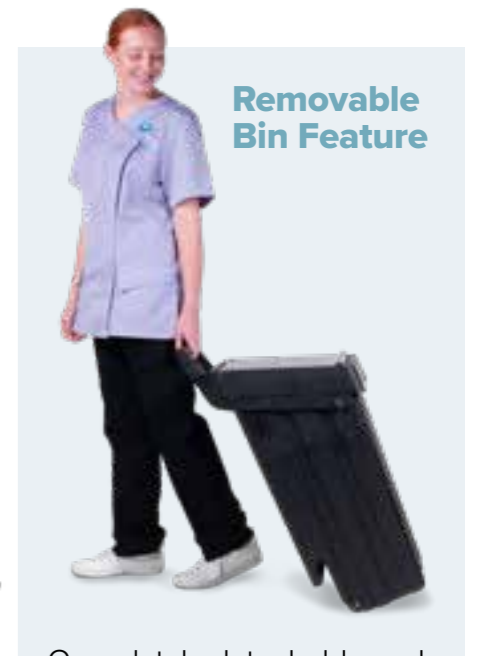

Removable Bin Feature

Completely detachable and manoeuvrable swing-out bin for convenient waste removal. Colour-coding options available for effective infection control.



PRO-Matic Mop Kits & Accessories

SRK Kits

<p>KIT SRK1S / SRK1KS</p>  <ul style="list-style-type: none"> Vertical Press for Flat or Kentucky/Twist Mop 1 x 17L Red Handle Bucket, Grey 1 x 17L Blue Handle Bucket, Grey 1 x Bucket Support Tray Used on: PM10 / 20 / 30 Flat Mop Press PN: 909523 Kentucky/Twist Mop Press PN: 910348 	<p>KIT SRK2S / SRK2KS</p>  <ul style="list-style-type: none"> Vertical Press for Flat or Kentucky/Twist Mop 1 x 22L Red Handle Bucket, Grey 1 x 22L Blue Handle Bucket, Grey 1 x Extension Tray Used on: PM10 / 20 / 30 Flat Mop Press PN: 909524 Kentucky/Twist Mop Press PN: 910349 	<p>KIT SRK3S</p>  <ul style="list-style-type: none"> Speedclean Wide Press with Stainless Steel Handle 1 x 22L Red Handle Bucket, Grey 1 x 22L Blue Handle Bucket, Grey 1 x Extension Tray Used on: PM10 / 20 / 30 PN: 909525 	<p>KIT SRK4</p>  <ul style="list-style-type: none"> 1 x MopMatic2 Bucket, Grey C/W Set of Colour-coded Discs C/W 2.5L Dosing Bottle 1 x 22L Red Handle Bucket, Grey 1 x Extension Tray Used on: PM10 / 20 / 30 PN: 910433 	
<p>KIT SRK5</p>  <ul style="list-style-type: none"> 2 x MopMatic2 Buckets, Grey C/W Set of Colour-coded Discs C/W 2.5L Dosing Bottle 1 x Extension Tray Used on: PM10 / 20 / 30 PN: 910435 	<p>KIT SRK6S</p>  <ul style="list-style-type: none"> 2 x MopMatic 2 Buckets, Grey C/W Set of Colour-coded Discs C/W 2.5L Dosing Bottle 1 x 22L Red Handle Bucket, Grey, C/W Lid MopMatic2 Hang-on Frame, Stainless Steel 1 x Extension Tray Used on: PM10 / 20 / 30 PN: 910436 	<p>MIDMOP OPTION MMB1616</p>  <ul style="list-style-type: none"> Vertical Press for Flat or Kentucky/Twist Mop 510x680x1020mm (WxLxH) Used on: PM10 / 20 / 30 	<p>KIT SRK62S</p>  <ul style="list-style-type: none"> Hood Set Lockable Used on: PM Range PN: 910316 	
<p>KIT SRK26</p>  <ul style="list-style-type: none"> Optional Doors C/W Locks and Hinges Used on: PM11 / 13 / 20 / 21 / 22 / 30 / 31 / 32 PN: 908171 	<p>KIT SRK30</p>  <ul style="list-style-type: none"> Optional Single Door and Back Panel C/W Locks and Hinges Used on: PM11 / 13 / 20 / 21 / 22 / 30 / 31 / 32 PN: 911444 	<p>KIT SRK31</p>  <ul style="list-style-type: none"> Optional Double Doors and 2 x Back Panels C/W Locks and Hinges Used on: PM13 / 21 / 30 / 31 / 32 PN: 911447 	<p>KIT SRK49</p>  <ul style="list-style-type: none"> Swing-out Bin Used on: PM10 / 11 / 12 / 20 / 21 / 22 / 30 / 31 / 32 PN: 912815 	<p>BAG SPLITTER KIT</p>  <ul style="list-style-type: none"> 1 x Bag Splitter with Fixing Screws for Dual Waste C/W Roll of 70L Waste Bags C/W Colour-coded Discs Used on: PM Range PN: 912817
<p>NUMATIC QUICK TROLLEY BRACKET</p>  <ul style="list-style-type: none"> 1 x Numatic Quick Trolley Bracket Used on: PM Range PN: 916341 		<p>CUSTOMISABLE DOOR PANELS</p> <p>KIT SRK27</p> <ul style="list-style-type: none"> Door Graphic Set No.1 Happy Cleaning PN: 908172 <p>KIT SRK28</p> <ul style="list-style-type: none"> Door Graphic Set No.2 Big Ben PN: 908173 <p>KIT SRK29</p> <ul style="list-style-type: none"> Door Graphic Set No.3 Sunflowers PN: 908174  <p>For a personalised door panel with your logo, get in touch today to find out more.</p>		

KIT	PART No.	EM1	EM2	EM3	EM4	EM5	EM6	SM0	SM1	SM2	SM3	SM4	SM5	PM10	PM11	PM12	PM13	PM20	PM21	PM22	PM30	PM31	PM32
SRK0	910413							•	•	•	•	•											
SRK0K	910414							•	•	•	•	•											
SRK1	910415							•	•	•	•	•											
SRK1K	910416							•	•	•	•	•											
SRK1S	909523													•				•				•	
SRK1KS	910348													•				•				•	
SRK2	910425							•	•	•	•	•											
SRK2K	910426							•	•	•	•	•											
SRK2S	909524													•				•				•	
SRK2KS	910349													•				•				•	
SRK3	910430							•	•	•	•	•											
SRK3S	909525													•				•				•	
SRK4	910433							•	•	•	•	•		•				•				•	
SRK5	910435							•	•	•	•	•		•				•				•	
SRK6	910436							•	•	•	•	•											
SRK6S	909526													•				•				•	
SRK8	911222													•				•				•	
SRK14	910439	•	•																				
SRK15	910440			•			•																
SRK16	910442			•			•																
SRK16K	910443			•			•																
SRK19	910843			•			•																
SRK20	910758	•	•	•	•	•	•	•	•	•	•	•	•	•	•	•	•	•	•	•	•	•	•
SRK21	910898	•	•	•	•	•	•	•	•	•	•	•	•	•	•	•	•	•	•	•	•	•	•
SRK22	911401	•	•	•	•	•	•	•	•	•	•	•	•	•	•	•	•	•	•	•	•	•	•
SRK26	908171							•	•	•	•	•	•	•	•	•	•	•	•	•	•	•	•
SRK27	908172							•	•	•	•	•	•	•	•	•	•	•	•	•	•	•	•
SRK28	908173							•	•	•	•	•	•	•	•	•	•	•	•	•	•	•	•
SRK29	908174							•	•	•	•	•	•	•	•	•	•	•	•	•	•	•	•
SRK30	911444							•	•	•	•	•	•	•	•	•	•	•	•	•	•	•	•
SRK31	911447																•		•		•	•	•
SRK35S	909072																	•	•	•	•	•	•
SRK36S	909073																				•	•	•
SRK42S	909075													•									
SRK43S	909076																		•				
SRK44S	909232																					•	
SRK49	912815													•	•	•		•	•	•	•	•	•
SRK50	912849																						
SRK51	912853																						
SRK62	910315							•	•	•	•	•	•										
SRK62S	910316													•	•	•	•	•	•	•	•	•	•



CAROUSEL

The Carousel is, without a doubt, not only an outstanding mobile cleaning module but also a very clever design providing several cleaning facilities in one exceptionally compact and easy to handle, user-friendly package.

NC0R



- Waste Bin 70L
- 2 x 5L Swing Pails
- C/W SprayMop Master and Tray
- Castors: 4 x 80mm
- 480x545x890mm (WxLxH)

NC1R



Image shows NC1R-TM

- Waste Bin 70L
- 1 x 4L Caddy
- 14L Bucket and Dolly Mop Basket
- Castors: 4 x 80mm
- Optional Twist Mop (NC1R-TM)
- 480x545x890mm (WxLxH)

NC2R



- Waste Bin 2 x 70L
- Castors: 4 x 80mm
- 480x545x890mm (WxLxH)

NC3R



- Waste Bin 70L
- 1 x 4L / 1 x 10L Caddy
- Castors: 4 x 80mm
- 480x545x890mm (WxLxH)

NC4R



- 2 x 4L / 2 x 10L Caddy
- Castors: 4 x 80mm
- 480x545x890mm (WxLxH)



NC0R with 2 x 5L Swing Pails, SprayMop Master and Tray. Consumables for illustration purposes only.

NUBAG

The NuBag range has been designed to provide space saving answers with super strong construction and a smaller capacity when needed.



Made using Recycled Plastic

ReFlo Technology uses the highest quality recycled plastic, delivering the same Numatic reliability, durability and quality as always.

Twin waste, linen and laundry modules have always been popular in commercial establishments. The dual-end design can incorporate waste and laundry, linen and laundry or waste and linen.

SERVO-X

Big in use, small in storage, the Servo-X trolley range will always find favour in the many locations where space is at an absolute premium.

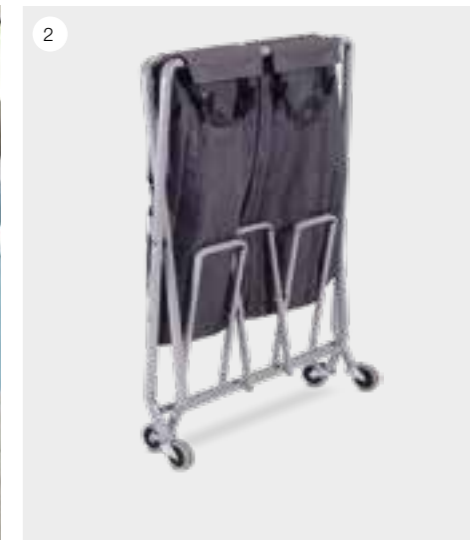

1 NX1002 (Consumables for illustration purposes only.)
2 X-Fold Design for Compact Storage
3 Integrated Laundry Bag Closure System

SAX120PR



NSX240R



NX1001



NX1002



LLT200R



NBT200R



NB3002R / AT



NX1501



NX2001



NX2401



MODEL	SAX120PR	NSX240R	LLT200R	NBT200R	NB3002R / AT
Bag Capacity	1 x 120L	2 x 120L	2 x 100L	2 x 100L	1 x 100L + 1 x 200L
Castor Size	4 x 75mm	4 x 75mm	4 x 75mm	4 x 75mm	4 x 200mm
Dimensions (WxLxH)	655x550x910mm	580x780x965mm	580x780x965mm	580x780x860mm	655x1110x1115mm

MODEL	NX1001	NX1002	NX1501	NX2001	NX2401
Bag Capacity	100L	2 x 100L	150L	200L	240L
Castor Size	4 x 75mm	4 x 75mm	4 x 75mm	4 x 75mm	4 x 75mm
Dimensions (WxLxH)	390x460x960mm	460x760x960mm	460x760x760mm	460x760x960mm	550x780x960mm

NUKEEPER

NKS Single & Low Level

Compact, considered and capable...
The NKS range will always be a welcome addition to housekeeping where space is at a real premium.



Consumables for illustration purposes only.



- 1 Folding Bag Ends & Heavy-Duty Construction
- 2 Easily Detachable Laundry Bags
- 3 Flexi-Front Enclosure
- 4 Numatic Quick Trolley Bracket

Compact Laundry Flexi-Front

NKS1LLR

NKS2LLR



NKS1R

NKS2R



MODEL	NKS1LLR	NKS2LLR	NKS1R	NKS2R
Bag Capacity	1 x 100L	2 x 100L	1 x 100L	2 x 100L
Castor Size	4 x 125mm	4 x 125mm	4 x 125mm	4 x 125mm
Height	Low Level	Low Level	Full Height	Full Height
Storage	1 x Shelf	1 x Shelf	2 x Shelves	2 x Shelves
Dimensions (WxLxH)	582x998x1026mm	582x1420x1026mm	582x998x1352mm	582x1420x1352mm

NUKEEPER

NKT Twin & Low Level

Compact in size... Big on storage. The NKT range has a Flexi-Front enclosure, rotating side buffers to protect walls and even a Low Level (LL) version when visibility during transit is a consideration.



Made using Recycled Plastic

ReFlo Technology uses the highest quality recycled plastic, delivering the same Numatic reliability, durability and quality as always.

Compact Laundry Flexi-Front



Consumables for illustration purposes only.



- 1 Easily Detachable Laundry Bags
- 2 Rotating Buffers for Wall & Door Protection
- 3 Folding Bag Ends & Heavy-Duty Construction

MODEL	NKT0R	NKT1R	NKT2R	NKTOLLR	NKT1LLR	NKT2LLR
Bag Capacity	-	1 x 100L	2 x 100L	-	1 x 100L	2 x 100L
Castor Size	4 x 125mm	4 x 125mm	4 x 125mm	4 x 125mm	4 x 125mm	4 x 125mm
Height	Full Height	Full Height	Full Height	Low Level	Low Level	Low Level
Storage	2 x Twin Shelves	2 x Twin Shelves	2 x Twin Shelves	1 x Twin Shelf	1 x Twin Shelf	1 x Twin Shelf
Dimensions (WxLxH)	582x940x1352mm	582x1361x1352mm	582x1783x1352mm	582x940x1026mm	582x1361x1026mm	582x1783x1026mm

NUKEEPER

NKU Professional Universal

The NuKeeper Universal has been designed in every way for demanding hotel cleaning regimes, tackling narrow corridors, heavy loads and the pressures of time sensitive public-space day cleaning.



NKU32RFF
(Flexi-Front with Hood Kit NKA8R)

NKU32RHF
(Hard-Front with Optional Trays)

Consumables for illustration purposes only.

NKU30RFF



NKU30RHF



NKU31RFF



NKU31RHF



NKU32RFF



NKU32RHF



**Space-Saving
Customisable
Secure**



1 NKU31RHF with Top Kit NKA11R

2 Lockable Tablet Option

3 Flexi-Front System

Consumables for illustration purposes only.

MODEL	NKU30RFF	NKU30RHF	NKU31RFF	NKU31RHF	NKU32RFF	NKU32RHF
Bag Capacity	-	-	1 x 100L	1 x 100L	2 x 100L	2 x 100L
Castor Size	4 x 200mm All-Terrain	4 x 200mm All-Terrain	4 x 200mm All-Terrain	4 x 200mm All-Terrain	4 x 200mm All-Terrain	4 x 200mm All-Terrain
Closure	Flexi-Front	Hard-Front Bi-fold Doors	Flexi-Front	Hard-Front Bi-fold Doors	Flexi-Front	Hard-Front Bi-fold Doors
Security	-	Lockable	-	Lockable	-	Lockable
Storage	1 x Twin Shelf	1 x Twin Shelf	1 x Twin Shelf	1 x Twin Shelf	1 x Twin Shelf	1 x Twin Shelf
Dimensions (WxLxH)	667x1116x1205mm	667x1116x1205mm	667x1532x1205mm	667x1532x1205mm	667x1948x1205mm	667x1948x1205mm

NUKEEPER

Top Tray & Hood Kits

A complete range of accessory kits provide the specification you need with no compromise.
For use on NKU models only.

<p>NKA1</p>  <ul style="list-style-type: none"> 1 x Tray with Lid 1 x Tray with Divisions and Lid 1 x Half Tray PN: 903698 	<p>NKA2</p>  <ul style="list-style-type: none"> 2 x Tray with Divisions and Lid 1 x Half Tray PN: 903699 	<p>NKA3</p>  <ul style="list-style-type: none"> 2 x Tray with Lid 1 x Half Tray PN: 903700 	
<p>NKA4</p>  <ul style="list-style-type: none"> 1 x Tray 1 x Tray with Divisions 1 x Half Tray PN: 903701 	<p>NKA5</p>  <ul style="list-style-type: none"> 2 x Tray 1 x Half Tray PN: 903702 	<p>NKA6</p>  <ul style="list-style-type: none"> 2 x Tray with Divisions 1 x Half Tray PN: 903703 	
<p>NKA7R</p>  <ul style="list-style-type: none"> 1 x Hood Set 1 x Half Tray PN: 913415 	<p>NKA8R</p>  <ul style="list-style-type: none"> 2 x Hood Set 1 x Half Tray PN: 913416 	<p>NKA9R</p>  <ul style="list-style-type: none"> 1 x Hood Set 1 x Tray with Lid 1 x Half Tray PN: 913417 	
<p>NKA10R</p>  <ul style="list-style-type: none"> 1 x Hood Set 1 x Tray with Divisions and Lid 1 x Half Tray PN: 913418 	<p>NKA11R</p>  <ul style="list-style-type: none"> 1 x Hood Set 1 x Tray 1 x Half Tray PN: 913419 	<p>NKA12R</p>  <ul style="list-style-type: none"> 1 x Hood Set 1 x Tray with Divisions 1 x Half Tray PN: 913420 	
<p>NKA13 TOP KIT</p>  <ul style="list-style-type: none"> Top Kit - Laundry Support Set PN: 907145 			<p>NKU3R2FF (Flexi-Front shown with Hood Kit NKA12R)</p>  <p>For illustration purposes, all tray kits are shown in location on trolley.</p>

End Frame Kits

<p>NKA100PR</p>  <ul style="list-style-type: none"> Bag Capacity 1 x 100L Optional Moulded Laundry Bag Extension Kit PN: 913190 	<p>NKA100PAR</p>  <ul style="list-style-type: none"> Bag Capacity 1 x 100L Optional Moulded Laundry Bag Extension Kit Adjustable Handle PN: 910627 	<p>NKA101PR</p>  <ul style="list-style-type: none"> Waste 1 x 120L Optional Moulded Full Waste Bag Extension Kit C/W 3-Piece Lid Set, Black PN: 913376
<p>NKA102PR</p>  <ul style="list-style-type: none"> Waste 1 x 140L / 2 x 70L Optional Moulded Twin Waste Bag Extension Kit C/W Split Lid Set, Red / Blue PN: 913395 	<p>NKA103PR</p>  <ul style="list-style-type: none"> Waste 1 x 120L Optional Moulded Linen Bag Extension Kit C/W 3 Piece Lid Set, Black PN: 913397 	<p>NKA140PR</p>  <ul style="list-style-type: none"> Waste 1 x 120L Optional Moulded Full Waste Bag Extension Kit C/W iPad / Tablet Storage Lid Set, Black PN: 913400
<p>NKA109UR</p>  <ul style="list-style-type: none"> Optional Vacuum Storage Platform and Support Frame Kit, Black Used on: NKU Models Only PN: 913402 	<p>NKA111UR</p>  <ul style="list-style-type: none"> Optional End Kit Twin End Half Tray Kit, Black Used on: All NKS / NKT / NKU Models PN: 913409 	<p>NKA112UR</p>  <ul style="list-style-type: none"> Optional End Kit Twin End Full Tray Kit, Black Used on: All NKS / NKT / NKU Models PN: 913411
<p>NKA120R</p>  <ul style="list-style-type: none"> Optional End Kit SprayMop Tray Kit, Black Used on: All NKS / NKT / NKU Models PN: 913412 	<p>NKA130UR</p>  <ul style="list-style-type: none"> Optional End Kit 30 Litre Waste Bin Kit, Black Used on: All NKS / NKT / NKU Models PN: 913413 	<p>NUMATIC QUICK TROLLEY BRACKET</p>  <ul style="list-style-type: none"> 1 x Numatic Quick Trolley Bracket Used on: All NKS / NKT / NKU Models PN: 916341

Numatic

Performance You Can Trust.

Head Office

Numatic International Limited

Chard, Somerset TA20 2GB
UNITED KINGDOM

Tel: +44 (0)1460 68600
numatic.com

Numatic International GmbH

Fränkische Straße 15-19
30455 Hannover
GERMANY

Tel: +49 511 984 2160
numatic.de

Numatic International Denmark

Fränkische Straße 15-19
30455 Hannover
GERMANY

Tel: +45 316 40808
numatic.dk

Numatic International S.A.S

13/17 rue du Valengelier
EAE la Tuilerie, 77500 Chelles
FRANCE

Tel: +33 164 726 161
numatic.fr

Numatic International BV

Vennootsweg 15
2404 CG, Alphen aan den Rijn
THE NETHERLANDS

Tel: +31 172 467 999
numatic.nl

Numatic International Schweiz AG.

Sihlbruggstrasse 3A
6340 Baar
SWITZERLAND

Tel: +41 41 768 0760
numatic.ch

Numatic International (PTY) Ltd.

Cnr. 16th & Pharmaceutical Road
Randjes Park
Midrand 1685
SOUTH AFRICA

Tel: +27 861 686 284
numatic.co.za

Numatic International LDA

Rua Francisco da Silva Duarte,
79 fração D
4475-269 Santa Maria de Avioso
Castêlo da Maia
PORTUGAL

Tel: +351 220 047 700
numatic.pt

Numatic International SLU

Av. Baix Llobregat
5-7, Oficina bajos 1
(Parc Negocis Mas Blau II)
08820 El Prat de Llobregat
Barcelona
SPAIN

Tel: +34 93 647 22 22
numatic.es

Numatic International Italy S.R.L

Via Luigi Galvani, 2
Z.I. Talponedo
33080 Porcia (PN)
ITALY

Tel: +39 434 046 211
numatic.it

